

John Guest[®]

Productos para sistemas de fluidos



Celebrando 50 Años de Innovación



Catálogo para EE. UU.
Junio 2011



John Guest Group tiene una reputación consolidada desde hace tiempo como líder mundial en la fabricación de conectores de empuje, tubos y otros productos para el control de fluidos. Una reputación forjada por la producción permanente de productos de alta calidad con un compromiso continuo de valorar la ingeniería y el desarrollo de productos.



Fabricación de calidad

Tanto el diseño como la fabricación se llevan a cabo en las modernas instalaciones de John Guest construidas especialmente para dichas tareas en el Reino Unido.

Llevar un control de la totalidad del proceso, desde el diseño inicial de la herramienta y su fabricación hasta el ensamblaje final y la prueba, garantiza que sólo se fabriquen productos de la más alta calidad.

Este compromiso con la calidad le ha proporcionado a la empresa prestigiosos premios de muchas de las organizaciones de evaluación y acreditación líderes en el mundo.

John Guest es un proveedor preferido para muchas empresas internacionales.



PRODUCTOS PARA SISTEMAS DE FLUIDOS



La línea estándar de conectores de empuje, válvulas de cierre y tuberías de polietileno de John Guest ha sido diseñada para su uso en una amplia gama de aplicaciones para el tratamiento de aguas industriales que incluyen purificación de agua, osmosis inversa, equipos para fabricar hielo, máquinas expendedoras de bebidas y servicio de café para oficinas (OCS), vehículos recreativos y marítimos, sistemas de lavado de automóviles y mucho más.

Los conectores son fáciles de utilizar y no se necesitan herramientas para realizar conexiones confiables y herméticas.

Los conectores de empuje, las válvulas de cierre y las tuberías de polietileno estándar se fabrican con materiales que cumplen con las normas de la Administración de Drogas y Alimentos y están incluidos en la lista de Normas Internacionales NSF (Fundación Nacional de Sanidad) 51 y 61.

ÍNDICE:

<p>CONECTORES DE POLIPROPILENO</p> <p>p5-6</p> 	<p>VÁLVULAS DE PASO DE POLIPROPILENO EN PULGADAS Y SIN PLOMO</p> <p>p19</p> 
<p>CONECTORES DE ACETAL</p> <p>p7-10</p> 	<p>VÁLVULAS DE PASO EN ÁNGULO DE ACETAL</p> <p>p19</p> 
<p>CONECTORES DE ACETAL BLANCO</p> <p>p11</p> 	<p>VÁLVULAS DE PASO DE ACETAL EN PULGADAS</p> <p>p20</p> 
<p>CONECTORES SUPERSEAL</p> <p>p12</p> 	<p>VÁLVULAS DE PASO Y DERIVACIÓN</p> <p>p20</p> 
<p>CONECTORES DE BRONCE</p> <p>p13</p> 	<p>TUBO LLDPE</p> <p>p21-22</p> 
<p>CONECTORES MÉTRICOS/EN PULGADAS</p> <p>p13</p> 	<p>ACCESORIOS</p> <p>p23</p> 
<p>CONECTORES DE POLIPROPILENO (MÉTRICOS)</p> <p>p14</p> 	<p>ESPECIFICACIONES TÉCNICAS</p> <p>p24</p> 
<p>CONECTORES DE ACETAL (MÉTRICOS)</p> <p>p15-17</p> 	<p>TÉRMINOS Y CONDICIONES</p> <p>p25-26</p> 
<p>VÁLVULAS ANGULARES CON ADAPTADOR DE POLIPROPILENO EN PULGADAS</p> <p>p18</p> 	

Cómo realizar una conexión estándar

CÓMO REALIZAR UNA BUENA CONEXIÓN:

Para realizar una conexión, el tubo simplemente se empuja con la mano. Luego, el sistema de bloqueo de casquillo único patentado por John Guest retiene el tubo con firmeza en el lugar sin deformarlo ni restringir el flujo.



MATERIALES DE CONSTRUCCIÓN

Los **conectores de John Guest** se fabrican con tres componentes:

Los **cuerpos** se fabrican con acetal copolímero o polipropileno.

Las **juntas tóricas** se fabrican con nitrilo o EPDM (etileno propileno dieno monómero).

Los **casquillos** se fabrican con acetal copolímero o polipropileno con dientes de acero inoxidable.

CORTAR EL TUBO A ESCUADRA



Corte el tubo a escuadra y elimine los bordes ásperos y filosos. Asegúrese de que el diámetro exterior no tenga estrías. Para una tubería plástica con paredes delgadas o blandas, recomendamos el uso de un casquillo para tubo.

EMPUJAR HASTA EL TAPÓN DEL TUBO



Empuje el tubo por el conector hasta el tapón.

TIRAR PARA VERIFICAR



Tire del tubo para verificar que esté firme.

PARA DESCONECTAR Empujar el casquillo y retirar el tubo



Para desconectar, asegúrese de que el sistema esté despresurizado, empuje el casquillo en ángulo recto hacia el conector. Con el casquillo en esta posición, se puede retirar el tubo.

Conectores de polipropileno en pulgadas

Para tubos de 1/4" a 1/2" de diámetro exterior se ofrece la gama PP de conectores de empuje en pulgadas. Los conectores se fabrican con polipropileno blanco con juntas tóricas de EPDM aprobadas para uso con alimentos. Han sido desarrollados para satisfacer necesidades de compatibilidad para una amplia gama de aplicaciones.

La gama PP NO es adecuada para aplicaciones con aire comprimido. Para estos casos, recomendamos la gama PI que aparece en las páginas 7 a 10.

Las juntas toricas EPDM no son compatibles con quimicos, pero resisten el cloro. La gama PP esta diseñada para aplicaciones de filtración de agua.

Presiones y temperaturas

Agua	Máx.	150 psi a 70°F	(Max. 10 bar a 20°C)
	Máx.	60 psi a 140°F	(Max. 4 bar a 60°C)
	Min.	33°F/1°C	

En la página 24 se incluye información técnica detallada. Los precios están sujetos a cambios sin previo aviso.



CONECTOR MACHO ROSCA NPTF



NRO. DE PIEZA	Ø EXT. TUBO	ROSCA NPTF	CANT. P. CAJA
---------------	-------------	------------	---------------

PP010821W	1/4	- 1/8	500
PP010822W	1/4	- 1/4	400
PP010823W	1/4	- 3/8	400
PP011222W	3/8	- 1/4	250
PP011223W	3/8	- 3/8	250
PP011224W	3/8	- 1/2	250
PP011623W	1/2	- 3/8	150
PP011624W	1/2	- 1/2	150

UNIÓN DOBLE



NRO. DE PIEZA	Ø EXT. TUBO	CANT. P. CAJA
---------------	-------------	---------------

PP0408W	1/4	400
PPM0408W	5/16	300
PP0412W	3/8	200
PP0416W	1/2	100

TAPÓN



NRO. DE PIEZA	Ø EXT. ESPIGA	CANT. P. CAJA
---------------	---------------	---------------

PP0808W	1/4	500
PPM0808W	5/16	500
PP0812W	3/8	400
PP0816W	1/2	300

TE



NRO. DE PIEZA	Ø EXT. TUBO	CANT. P. CAJA
---------------	-------------	---------------

PP0208W	1/4	300
PPM0208W	5/16	200
PP0212W	3/8	100
PP0216W	1/2	80
Casquillo azul		
PP0208W-B	1/4	300

ADAPTADOR ESPIGA ROSCA NPTF



NRO. DE PIEZA	Ø EXT. ESPIGA	ROSCA NPTF	CANT. P. CAJA
---------------	---------------	------------	---------------

PP050821W	1/4	x 1/8	500
PP050822W	1/4	x 1/4	500
PP051222W	3/8	x 1/4	300
PP051223W	3/8	x 3/8	200
PP051623W	1/2	x 3/8	250
PP051624W	1/2	x 1/2	200

CODO GIRATORIO ROSCA NPTF



NRO. DE PIEZA	Ø EXT. TUBO	ROSCA NPTF	CANT. P. CAJA
---------------	-------------	------------	---------------

PP090821W	1/4	x 1/8	300
PP090822W	1/4	x 1/4	200
PP091222W	3/8	x 1/4	100
PP091223W	3/8	x 3/8	100

CODO



NRO. DE PIEZA	Ø EXT. TUBO	CANT. P. CAJA
---------------	-------------	---------------

PP0308W	1/4	400
PPM0308W	5/16	300
PP0312W	3/8	200
PP0316W	1/2	100
Casquillo azul		
PP0308W-B	1/4	400

REDUCTOR



NRO. DE PIEZA	Ø EXT. ESPIGA	Ø EXT. TUBO	CANT. P. CAJA
---------------	---------------	-------------	---------------

PP061208W	3/8	- 1/4	400
PP061612W	1/2	- 3/8	200
PP062008W	5/8	- 1/4	200
PP062012W	5/8	- 3/8	200
PP062016W	5/8	- 1/2	150

TE GIRATORIO CON ROSCA BASE ROSCA NPTF



NRO. DE PIEZA	Ø EXT. TUBO	ROSCA NPTF	CANT. P. CAJA
---------------	-------------	------------	---------------

PP100821W	1/4	x 1/8	200
PP100822W	1/4	x 1/4	200
PP101222W	3/8	x 1/4	100
PP101223W	3/8	x 3/8	100

TE MACHO LATERAL GIRATORIO

ROSCA NPTF



NRO. DE PIEZA	Ø EXT. TUBO	ROSCA NPTF	CANT. P. CAJA
PP110821W	1/4 x	1/8	200
PP110822W	1/4 x	1/4	200
PP111222W	3/8 x	1/4	100
PP111223W	3/8 x	3/8	100

PASATABIQUES



NRO. DE PIEZA	Ø EXT. TUBO	Diám. del orificio de montaje	CANT. P. CAJA
PP1208W	1/4	0.67	200
PP1212W	3/8	0.83	100
PP1216W	1/2	1.06	50

Los pasatabiques de polipropileno no están fabricados para ser utilizados bajo el agua.

PASATABIQUE DE REDUCCIÓN



NRO. DE PIEZA	Ø EXT. TUBO	Ø EXT. TUBO	Diám. del orificio de montaje	CANT. P. CAJA
PP121208W	3/8	1/4	0.83	150

UNIÓN REDUCIDO



NRO. DE PIEZA	Ø EXT. TUBO	Ø EXT. TUBO	CANT. P. CAJA
PP201208W	3/8	- 1/4	250
PP201612W	1/2	- 3/8	150

CODO REDUCIDA



NRO. DE PIEZA	Ø EXT. TUBO	Ø EXT. TUBO	CANT. P. CAJA
PP211008W	5/16	- 1/4	300
PP211208W	3/8	- 1/4	200
PP211612W	1/2	- 3/8	150

CODO ESPIGA



NRO. DE PIEZA	Ø EXT. ESPIGA	Ø EXT. TUBO	CANT. P. CAJA
PP220808W	1/4	- 1/4	500
PPM220808W	5/16	- 5/16	400
PP221208W	3/8	- 1/4	300
PP221212W	3/8	- 3/8	200
PP221616W	1/2	- 1/2	150
Casquillo azul			
PP221212W-B	3/8	- 3/8	200

DIVISOR DE DOS VÍAS



NRO. DE PIEZA	Ø EXT. TUBO	CANT. P. CAJA
PP2312W	3/8	150

ESPIGA TUBO A MANGUERA



NRO. DE PIEZA	Ø EXT. TUBO	Ø INT. MANGUERA	CANT. P. CAJA
PP251212W	3/8	- 3/8	400
PP251216W	3/8	- 1/2	300
PP251612W	1/2	- 3/8	300
PP251616W	1/2	- 1/2	250

TE DE REDUCIDA



NRO. DE PIEZA	Ø EXT. EXTREMO DEL TUBO	Ø EXT. RACOR DEL TUBO	CANT. CAJA
PP30120812W	3/8	1/4 3/8	150
PP30121208W	3/8	3/8 1/4	150
PP301612W	1/2	1/2 3/8	50

CONECTOR DE MEZCLADORA ROSCA UNS



NRO. DE PIEZA	Ø EXT. TUBO	ROSCA UNS	CANT. P. CAJA
PP3208U7W	1/4 x	7/16 - 24	400
PP3212U7W	3/8 x	7/16 - 24	300

ADAPTADOR HEMBRA ROSCA NPTF



NRO. DE PIEZA	Ø EXT. TUBO	ROSCA NPTF	CANT. P. CAJA
PP450821W	1/4 x	1/8	400
PP450822W	1/4 x	1/4	200
PP451222W	3/8 x	1/4	200
PP451223W	3/8 x	3/8	150

CODO ROSCA MACHO ROSCA NPTF



NRO. DE PIEZA	Ø EXT. TUBO	ROSCA NPTF	CANT. P. CAJA
PP480821W	1/4 x	1/8	500
PP480822W	1/4 x	1/4	400
PP480823W	1/4 x	3/8	300
PP481222W	3/8 x	1/4	200
PP481223W	3/8 x	3/8	200

DIVISOR DE TRES VÍAS



NRO. DE PIEZA	Ø EXT. EXTREMO DEL TUBO	Ø EXT. RACOR DEL TUBO	CANT. CAJA
PP491208W	3/8	x 1/4	150

LOS ACCESORIOS PARA LOS CONECTORES PP APARECEN EN LA PÁGINA 23.



Conectores de acetal en pulgadas

Para los tubos de 5/32" a 5/8" de diámetro exterior se ofrece la gama PI de conectores de empuje en pulgadas. Los conectores se fabrican con acetal copolímero gris con juntas tóricas de nitrilo aprobadas para el uso con alimentos, lo que los hace especialmente adecuados para aplicaciones que involucran productos alimenticios y líquidos potables. También son adecuados para aire, gases inertes y por lo tanto pueden utilizarse en líneas de CO₂, aplicaciones neumáticas y al vacío.

**En la página 24 se incluye información técnica detallada.
Los precios están sujetos a cambios sin previo aviso.**



CONECTOR MACHO ROSCA NPTF



NRO. DE PIEZA	Ø EXT. TUBO	ROSCA NPTF	CANT. P. CAJA
PM010421S	5/32	x 1/8	500
PM010422S	5/32	x 1/4	500
PI010621S	3/16	x 1/8	500
PI010821S	1/4	x 1/8	500
PI010822S	1/4	x 1/4	400
PI010823S	1/4	x 3/8	300
PM010821S	5/16	x 1/8	400
PM010822S	5/16	x 1/4	400
PM010823S	5/16	x 3/8	300
PI011221S	3/8	x 1/8	250
PI011222S	3/8	x 1/4	250
PI011223S	3/8	x 3/8	250
PI011224S	3/8	x 1/2	200
PI011623S	1/2	x 3/8	150
PI011624S	1/2	x 1/2	150
PI012026S	5/8	x 3/4	100

CONECTOR MACHO ROSCA BSPT



NRO. DE PIEZA	Ø EXT. TUBO	ROSCA BSPT	CANT. P. CAJA
PM010401S	5/32	x 1/8	500
PM010402S	5/32	x 1/4	500
PI010601S	3/16	x 1/8	500
PI010602S	3/16	x 1/4	500
PI010801S	1/4	x 1/8	500
PI010802S	1/4	x 1/4	400
PM010801S	5/16	x 1/8	400
PM010802S	5/16	x 1/4	400
PM010803S	5/16	x 3/8	300
PI011202S	3/8	x 1/4	250
PI011203S	3/8	x 3/8	250
PI011603S	1/2	x 3/8	150
PI011604S	1/2	x 1/2	150

CONECTOR MACHO ROSCA BSPP



NRO. DE PIEZA	Ø EXT. TUBO	ROSCA BSPP	CANT. P. CAJA
PI010812S	1/4	x 1/4	250
PI011212S	3/8	x 1/4	250

CONECTOR MACHO ROSCA BSPP



NRO. DE PIEZA	Ø EXT. TUBO	ROSCA BSPP	CANT. P. CAJA
NCPI011211S	3/8	x 1/8	200
NCPI011212S	3/8	x 1/4	250

3/8" x 1/4" tiene un sellado amplio y especial para el uso con orificios frontales biselados. Sin sello de rosca en 3/8" x 1/8".

CONECTOR MACHO FLARE ROSCA MFL



FLARE 45°

NRO. DE PIEZA	Ø EXT. TUBO	ROSCA MFL	CANT. P. CAJA
PI0108F4S	1/4	x 1/4	300
PM0108F5S	5/16	x 5/16	500
PI0112F4S	3/8	x 1/4	250
PI0112F5S	3/8	x 5/16	250
PI0112F6S	3/8	x 3/8	300
PI0112F8S	3/8	x 1/2	200
PI0116F8S	1/2	x 1/2	200
PM0108C5S	5/16	x 1/2 - 16UN	400
PI0112C5S	3/8	x 1/2 - 16UN	200

1/4" (MFL) corresponde a 7/16-20 UNF
5/16" (MFL) corresponde a 1/2-20 UNF
3/8" (MFL) corresponde a 5/8-18 UNF
1/2" (MFL) corresponde a 3/4-16 UNF

ADAPTADOR DE SALIDA ROSCA BSPP



NRO. DE PIEZA	Ø EXT. TUBO	ROSCA BSPP	CANT. P. CAJA
NC128/I12	3/8	x 1/4	200

TE



NRO. DE PIEZA	Ø EXT. TUBO	CANT. P. CAJA
PM0204S	5/32	400
PI0206S	3/16	400
PI0208S	1/4	300
PM0208S	5/16	200
PI0212S	3/8	100
PI0216S	1/2	50

CODO



NRO. DE PIEZA	Ø EXT. TUBO	CANT. P. CAJA
PM0304S	5/32	500
PI0306S	3/16	500
PI0308S	1/4	400
PM0308S	5/16	300
PI0312S	3/8	200
PI0316S	1/2	100
Casquillo azul		
PI0308S-B	1/4	400

UNIÓN



NRO. DE PIEZA	Ø EXT. TUBO	CANT. P. CAJA
PM0404S	5/32	500
PI0406S	3/16	500
PI0408S	1/4	400
PM0408S	5/16	300
PI0412S	3/8	200
PI0416S	1/2	100

ADAPTADOR ESPIGA ROSCA NPTF



NRO. DE PIEZA	Ø EXT. ESPIGA	ROSCA NPTF	CANT. P. CAJA
PM050421S	5/32	x 1/8	500
PM050422S	5/32	x 1/4	500
PI050621S	3/16	x 1/8	500
PI050821S	1/4	x 1/8	500
PI050822S	1/4	x 1/4	500
PI050823S	1/4	x 3/8	300
PM050821S	5/16	x 1/8	500
PM050822S	5/16	x 1/4	500
PM050823S	5/16	x 3/8	300
PI051222S	3/8	x 1/4	300
PI051223S	3/8	x 3/8	300
PI051623S	1/2	x 3/8	150
PI051624S	1/2	x 1/2	150

ADAPTADOR ESPIGA ROSCA BSPT



NRO. DE PIEZA	Ø EXT. ESPIGA	ROSCA BSPT	CANT. P. CAJA
---------------	---------------	------------	---------------

PI050601S	3/16 x 1/8	500
PI050801S	1/4 x 1/8	500
PI050802S	1/4 x 1/4	500
PM050801S	5/16 x 1/8	500
PM050802S	5/16 x 1/4	500
PM050803S	5/16 x 3/8	300
PI051202S	3/8 x 1/4	300
PI051203S	3/8 x 3/8	300
PI051603S	1/2 x 3/8	200
PI051604S	1/2 x 1/2	150

ADAPTADOR ESPIGA ROSCA BSPP



NRO. DE PIEZA	Ø EXT. ESPIGA	ROSCA BSPP	CANT. P. CAJA
---------------	---------------	------------	---------------

PM050812S	5/16 x 1/4	500
PI051212S	3/8 x 1/4	300
PI051213S	3/8 x 3/8	300

REDUCIDO



NRO. DE PIEZA	Ø EXT. ESPIGA	Ø EXT. TUBO	CANT. P. CAJA
---------------	---------------	-------------	---------------

PI060605S	3/16 - 5/32	500
PI061006S	5/16 - 3/16	500
PI061008S	5/16 - 1/4	500
PI061206S	3/8 - 3/16	500
PI061208S	3/8 - 1/4	400
PI061210S	3/8 - 5/16	400
PI061610S	1/2 - 5/16	300
PI061612S	1/2 - 3/8	250

TAPÓN



NRO. DE PIEZA	Ø EXT. ESPIGA	CANT. P. CAJA
---------------	---------------	---------------

PM0804S	5/32	1000
PI0806S	3/16	1000
PI0808S	1/4	500
PM0808S	5/16	500
PI0812S	3/8	400
PI0816S	1/2	300

CODO GIRATORIO ROSCA NPTF



NRO. DE PIEZA	Ø EXT. TUBO	ROSCA NPTF	CANT. P. CAJA
---------------	-------------	------------	---------------

PM090421S	5/32 x 1/8	400
PM090422S	5/32 x 1/4	300
PI090621S	3/16 x 1/8	400
PI090821S	1/4 x 1/8	300
PI090822S	1/4 x 1/4	200
PM090821S	5/16 x 1/8	300
PM090822S	5/16 x 1/4	200
PM090823S	5/16 x 3/8	200
PI091221S	3/8 x 1/8	200
PI091222S	3/8 x 1/4	100
PI091223S	3/8 x 3/8	100
PI091622S	1/2 x 1/4	100
PI091623S	1/2 x 3/8	50
PI091624S	1/2 x 1/2	50

CODO GIRATORIO ROSCA BSPT



NRO. DE PIEZA	Ø EXT. TUBO	ROSCA BSPT	CANT. P. CAJA
---------------	-------------	------------	---------------

PI090601S	3/16 x 1/8	400
PI090801S	1/4 x 1/8	300
PI090802S	1/4 x 1/4	200
PM090801S	5/16 x 1/8	200
PM090802S	5/16 x 1/4	200
PM090803S	5/16 x 3/8	200
PI091202S	3/8 x 1/4	100
PI091203S	3/8 x 3/8	100
PI091603S	1/2 x 3/8	50
PI091604S	1/2 x 1/2	50

RACOR EN TE GIRATORIA BASE ROSCA NPTF



NRO. DE PIEZA	Ø EXT. TUBO	ROSCA NPTF	CANT. P. CAJA
---------------	-------------	------------	---------------

PM100421S	5/32 x 1/8	200
PM100422S	5/32 x 1/4	200
PI100621S	3/16 x 1/8	200
PI100821S	1/4 x 1/8	200
PI100822S	1/4 x 1/4	200
PM100821S	5/16 x 1/8	100
PM100822S	5/16 x 1/4	100
PM100823S	5/16 x 3/8	100
PI101222S	3/8 x 1/4	100
PI101223S	3/8 x 3/8	100
PI101623S	1/2 x 3/8	50
PI101624S	1/2 x 1/2	50

RACOR EN TE GIRATORIA BASE ROSCA BSPT



NRO. DE PIEZA	Ø EXT. TUBO	ROSCA BSPT	CANT. P. CAJA
---------------	-------------	------------	---------------

PI100601S	3/16 x 1/8	200
PI100801S	1/4 x 1/8	200
PI100802S	1/4 x 1/4	200
PM100801S	5/16 x 1/8	100
PM100802S	5/16 x 1/4	100
PM100803S	5/16 x 3/8	100
PI101202S	3/8 x 1/4	100
PI101203S	3/8 x 3/8	100
PI101603S	1/2 x 3/8	50
PI101604S	1/2 x 1/2	50

TE MACHO LATERAL GIRATORIO ROSCA NPTF



NRO. DE PIEZA	Ø EXT. TUBO	ROSCA NPTF	CANT. P. CAJA
---------------	-------------	------------	---------------

PM110421S	5/32 x 1/8	400
PM110422S	5/32 x 1/4	400
PI110621S	3/16 x 1/8	200
PI110821S	1/4 x 1/8	200
PI110822S	1/4 x 1/4	200
PM110821S	5/16 x 1/8	100
PM110822S	5/16 x 1/4	100
PM110823S	5/16 x 3/8	100
PI111222S	3/8 x 1/4	100
PI111223S	3/8 x 3/8	100
PI111623S	1/2 x 3/8	50
PI111624S	1/2 x 1/2	50

TE MACHO LATERAL GIRATORIO ROSCA BSPT



NRO. DE PIEZA	Ø EXT. TUBO	ROSCA BSPT	CANT. P. CAJA
---------------	-------------	------------	---------------

PI110601S	3/16 x 1/8	200
PI110801S	1/4 x 1/8	200
PI110802S	1/4 x 1/4	200
PM110801S	5/16 x 1/8	100
PM110802S	5/16 x 1/4	100
PM110803S	5/16 x 3/8	100
PI111202S	3/8 x 1/4	100
PI111203S	3/8 x 3/8	100
PI111603S	1/2 x 3/8	50
PI111604S	1/2 x 1/2	50

Adaptabilidad de John Guest

Los productos **Super Speedfit** pueden acoplarse para formar conectores totalmente nuevos.

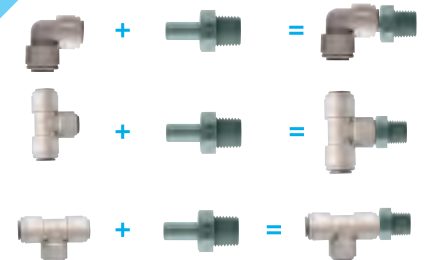

PASATABIQUES



NRO. DE PIEZA	Ø EXT. TUBO	Diám. del orificio de montaje	CANT. P. CAJA
PM1204S	5/32	0,67	200
PI1206S	3/16	0,67	200
PI1208S	1/4	0,67	200
PM1208S	5/16	0,83	100
PI1212S	3/8	0,83	100
PI1216S	1/2	1,06	50

PASATABIQUE DE REDUCCIÓN



NRO. DE PIEZA	Ø EXT. TUBO	Ø EXT. TUBO	Diám. del orificio de montaje	CANT. P. CAJA
NC392-02	1/2	1/4	0,83	150
PI121208S	3/8	1/4	0,83	150

ALARGADOR



NRO. DE PIEZA	Ø EXT. ESPIGA	Ø EXT. TUBO	CANT. P. CAJA
PI131012S	5/16	3/8	250
PI131216S	3/8	1/2	200

UNIÓN REDUCIDA



NRO. DE PIEZA	Ø EXT. TUBO	Ø EXT. TUBO	CANT. P. CAJA
PI200806S	1/4	3/16	200
PM200804S	5/16	5/32	300
PI201006S	5/16	3/16	200
PI201008S	5/16	1/4	200
PI201206S	3/8	3/16	200
PI201208S	3/8	1/4	200
PI201210S	3/8	5/16	200
PI201610S	1/2	5/16	100
PI201612S	1/2	3/8	100

CODO DE REDUCIDO



NRO. DE PIEZA	Ø EXT. TUBO	Ø EXT. TUBO	CANT. P. CAJA
PM210804S	5/16	5/32	300
PI211006S	5/16	3/16	200
PI211008S	5/16	1/4	200
PI211206S	3/8	3/16	200
PI211208S	3/8	1/4	200
PI211210S	3/8	5/16	200
PI211610S	1/2	5/16	100
PI211612S	1/2	3/8	100

CODO ESPIGA



NRO. DE PIEZA	Ø EXT. ESPIGA	Ø EXT. TUBO	CANT. P. CAJA
PM220404S	5/32	5/32	500
PI220606S	3/16	3/16	500
PI220808S	1/4	1/4	500
PM220808S	5/16	5/16	400
PI221206S	3/8	3/16	300
PI221208S	3/8	1/4	300
PI221210S	3/8	5/16	200
PI221212S	3/8	3/8	200
PI221616S	1/2	1/2	100

DIVISOR DE DOS VÍAS



NRO. DE PIEZA	Ø EXT. TUBO	CANT. P. CAJA
PI2308S	1/4	150
PM2308S	5/16	100
PI2312S	3/8	100
PI2316S	1/2	100

DIVISOR DE DOS VÍAS DESIGUALES



NRO. DE PIEZA	Ø EXT. EXTREMO DEL TUBO	Ø EXT. RACOR DEL TUBO	CANT. CAJA
PI241210S	3/8	5/16	100

ESPIGA TUBO A MANGUERA



NRO. DE PIEZA	Ø EXT. ESPIGA	Ø INT. MANGUERA	CANT. P. CAJA
PI250806S	1/4	3/16	500
PI250808S	1/4	1/4	500
PI250810S	1/4	5/16	500
PI251006S	5/16	3/16	500
PI251008S	5/16	1/4	500
PM250808S	5/16	5/16	500
PI251012S	5/16	3/8	400
PI251208S	3/8	1/4	400
PI251210S	3/8	5/16	400
PI251212S	3/8	3/8	400
PI251216S	3/8	1/2	300
PI251612S	1/2	3/8	300
PI251616S	1/2	1/2	200

ESPIGA TUBO A MANGUERA VERSIÓN LARGA



NRO. DE PIEZA	Ø EXT. ESPIGA	Ø INT. MANGUERA	CANT. P. CAJA
PI251012SL	5/16	3/8	400
PI251212SL	3/8	3/8	400

CODO TUBO A MANGUERA



NRO. DE PIEZA	Ø EXT. ESPIGA	Ø INT. MANGUERA	CANT. P. CAJA
PI290808S	1/4	1/4	500
PI290810S	1/4	5/16	500
PI291008S	5/16	1/4	500
PM290808S	5/16	5/16	500
PI291208S	3/8	1/4	400
PI291210S	3/8	5/16	400

TE DE REDUCCIÓN



NRO. DE PIEZA	Ø EXT. EXTREMO DEL TUBO	Ø EXT. RACOR DEL TUBO	CANT. CAJA
PI301208S	3/8	1/4	150
PI301612S	1/2	3/8	50

LOS ACCESORIOS PARA LOS CONECTORES PI APARECEN EN LA PÁGINA 23.



ADAPTADOR PARA GRIFO ROSCO BSPP

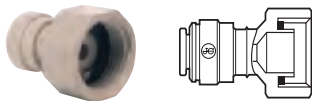

NRO. DE PIEZA	Ø EXT. TUBO	ROSCA BSPP	CANT. P. CAJA
CI320814S	1/4 x 1/2		150
CI320816S	1/4 x 3/4		150
CI321214S	3/8 x 1/2		100
CI321216S	3/8 x 3/4		100

No es adecuado para aire

ADAPTADOR PARA GRIFO ROSCO UNS

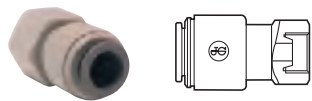

NRO. DE PIEZA	Ø EXT. TUBO	ROSCA UNS	CANT. P. CAJA
CI3208U7S	1/4 x 7/16 - 24		250
CI3210U7S	5/16 x 7/16 - 24		300
CI3212U7S	3/8 x 7/16 - 24		200

No es adecuado para aire

CONECTOR DE MEZCLADORA ROSCO NPTF

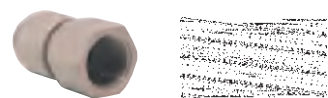

NRO. DE PIEZA	Ø EXT. TUBO	ROSCA NPTF	CANT. P. CAJA
PI450822S	1/4 x 1/4		400
PI451222S	3/8 x 1/4		250

CONECTOR DE MEZCLADORA ROSCO UN

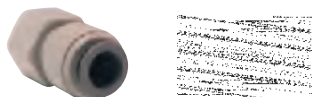

NRO. DE PIEZA	Ø EXT. TUBO	ROSCA UN	CANT. P. CAJA
PM4508C5S	5/16 x 1/2 - 16		300
PI4512C5S	3/8 x 1/2 - 16		200
PI4516C5S	1/2 x 1/2 - 16		200

CONECTOR DE MEZCLADORA FLARE ROSCA FFL

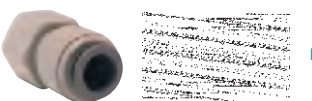

FLARE 45°

NRO. DE PIEZA	Ø EXT. TUBO	ROSCA UN	CANT. P. CAJA
PM4508F4S	5/16 x 1/4		300
PI4512F4S	3/8 x 1/4		250
PI4512F6S	3/8 x 3/8		200

1/4 (FFL) corresponde a 7/16 - 20 UNF
3/8 (FFL) corresponde a 5/8 - 18 UNF

CONECTOR DE MEZCLADORA ROSCA BSPP - EXTREMO CÓNICO



NRO. DE PIEZA	Ø EXT. TUBO	ROSCA BSPP	CANT. P. CAJA
PI451014CS	5/16 x 1/2		150
PI451015CS	5/16 x 5/8		150
PI451214CS	3/8 x 1/2		150
PI451215CS	3/8 x 5/8		100
PI451614CS	1/2 x 1/2		150
PI451616CS	1/2 x 3/4		100

CONECTOR DE MEZCLADORA ROSCA BSPP - EXTREMO PLANO



NRO. DE PIEZA	Ø EXT. TUBO	ROSCA BSPP	CANT. P. CAJA
PI451014FS	5/16 x 1/2		150
PI451015FS	5/16 x 5/8		150
PI451213S	3/8 x 3/8		150
PI451214FS	3/8 x 1/2		150
PI451215FS	3/8 x 5/8		150
PI451613S	1/2 x 3/8		150
PI451615FS	1/2 x 5/8		150

TAPÓN



NRO. DE PIEZA	Ø EXT. TUBO	CANT. P. CAJA
PI4608S	1/4	500
PI4612S	3/8	500

CRUZ



NRO. DE PIEZA	Ø EXT. TUBO	CANT. P. CAJA
PI4712S	3/8	100

CODO ROSCA MACHO ROSCO NPTF



NRO. DE PIEZA	Ø EXT. TUBO	ROSCA NPTF	CANT. P. CAJA
PI480821S	1/4 x 1/8		500
PI480822S	1/4 x 1/4		400
PI480823S	1/4 x 3/8		300
PI481022S	5/16 x 1/4		300
PI481023S	5/16 x 3/8		300
PI481222S	3/8 x 1/4		200
PI481223S	3/8 x 3/8		200
PI482024S	5/8 x 1/2		100

DIVISOR DE TRES VÍAS



NRO. DE PIEZA	Ø EXT. EXTREMO DEL TUBO	Ø EXT. RACOR DEL TUBO	CANT. CAJA
PI491612S	1/2	3/8	50

CODO DE VÁLVULA DISPENSADORA



NRO. DE PIEZA	Ø EXT. TUBO	Ø INT. MANGUERA	CANT. P. CAJA
NC356-02	3/8	3/8	250

ESPIGA DE VÁLVULA DISPENSADORA



NRO. DE PIEZA	Ø INT. MANGUERA	CANT. P. CAJA
NC730-02	3/8	500

CONECTOR DE AJUSTE



NRO. DE PIEZA	Ø EXT. TUBO	Ø EXT. TUBO	CANT. P. CAJA
NC641	1/2	5/16	200

CONECTOR EN U

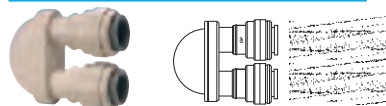

NRO. DE PIEZA	Ø EXT. TUBO	CANT. P. CAJA
PIUB12S	3/8	100
PIUB16S	1/2	50

Para tubos con 1/2 pulgada de diámetro exterior, se ofrece el conector en U. Los tubos de 1/2 pulgada de diámetro interior existentes pueden adaptarse con una espiga tubo a manguera estándar.

VÁLVULA ANTI RETORNO



Las válvulas anti retorno individuales Super Speedfit permiten que el flujo circule en una sola dirección.

Sólo para líquidos

NRO. DE PIEZA	Ø EXT. TUBO	CANT. P. CAJA
1/4SCV	1/4	300
5/16SCV	5/16	300
3/8SCV	3/8	80



NSF 51
NSF 61

Conectores de acetal en pulgadas (blancos)

Para tubos de 1/4" a 3/8" de diámetro exterior se ofrece la gama CI de conectores de empuje en pulgadas. Los conectores se fabrican con acetal blanco con una junta tórica de EPDM aprobada para uso con alimentos. Han sido desarrollados para la industria del agua pero son igualmente adecuados para otros líquidos potables. También se recomiendan para aplicaciones de agua caliente intermitente.

Los artículos seleccionados están disponibles con casquillos rojos o azules.

La gama CI NO es adecuada para aplicaciones con aire comprimido. Para estos casos, recomendamos la gama PI que aparece en las páginas 7 a 10.

Presiones y temperaturas

Agua	Máx.	150 psi a 70°F	(Max. 10 bar a 20°C)
	Máx.	100 psi a 150°F	(Max. 7 bar a 65°C)
	Min.	33°F/1°C	

En la página 24 se incluye información técnica detallada.

Los precios están sujetos a cambios sin previo aviso.

CONECTOR MACHO ROSCA NPTF



NRO. DE PIEZA	Ø EXT. TUBO	ROSCA NPTF	CANT. P. CAJA
CI010821W	1/4 x	1/8	500
CI010822W	1/4 x	1/4	400
CI010823W	1/4 x	3/8	300
CI011222W	3/8 x	1/4	250

CODO IGUAL



NRO. DE PIEZA	Ø EXT. TUBO	CANT. P. CAJA
CI0208W	1/4	300
CI0212W	3/8	100
Casquillo azul CI0208WB	1/4	300

CODO IGUAL



NRO. DE PIEZA	Ø EXT. TUBO	CANT. P. CAJA
CI0308W	1/4	400
CI0312W	3/8	200
Casquillo azul CI0308WB	1/4	400
CI0312WB	3/8	200
Casquillo rojo CI0312WR	3/8	200

UNIÓN DOBLE



NRO. DE PIEZA	Ø EXT. TUBO	CANT. P. CAJA
CI0408W	1/4	400
CI0412W	3/8	200

ADAPTADOR ESPIGA ROSCA NPTF



NRO. DE PIEZA	Ø EXT. ESPIGA	ROSCA NPTF	CANT. P. CAJA
CI050821W	1/4 x	1/8	500
CI050822W	1/4 x	1/4	500
CI051222W	3/8 x	1/4	300
CI051223W	3/8 x	3/8	300

REDUCTOR



NRO. DE PIEZA	Ø EXT. ESPIGA	Ø EXT. TUBO	CANT. P. CAJA
CI061208W	3/8	- 1/4	400

PASATABIQUES



NRO. DE PIEZA	Ø EXT. TUBO	Diám. del orificio de montaje	CANT. P. CAJA
CI1208W	1/4	0,67	200

CODO DE REDUCCIÓN



NRO. DE PIEZA	Ø EXT. TUBO	Ø EXT. TUBO	CANT. P. CAJA
CI211206W	3/8	- 3/16	200

CONECTOR DE MEZCLADORA ROSCA NPTF



NRO. DE PIEZA	Ø EXT. TUBO	ROSCA NPTF	CANT. P. CAJA
CI451222W	3/8	- 1/4	250

CODO ESPIGA



NRO. DE PIEZA	Ø EXT. ESPIGA	Ø EXT. TUBO	CANT. P. CAJA
CI220808W	1/4	- 1/4	500
CI221208W	3/8	- 1/4	300
CI221212W	3/8	- 3/8	200

Casquillo azul

CI220808WB	1/4	- 1/4	500
CI221212WB	3/8	- 3/8	200

Casquillo rojo

CI220808WR	1/4	- 1/4	500
CI221212WR	3/8	- 3/8	200

CONECTOR A MANGUERA SUPERSEAL X MANGUERA



NRO. DE PIEZA	Ø EXT. SUPERSEAL	Ø INT. MANGUERA	CANT. P. CAJA
CI270808W	1/4	- 1/4	300

TUBE TO HOSE ELBOW



NRO. DE PIEZA	Ø EXT. ESPIGA	Ø INT. MANGUERA	CANT. P. CAJA
CI291208W	3/8	- 1/4	400

CODO ROSCA MACHO ROSCA NPTF



NRO. DE PIEZA	Ø EXT. ESPIGA	ROSCA NPTF	CANT. P. CAJA
CI480821W	1/4 x	1/8	500
CI480822W	1/4 x	1/4	400
CI480823W	1/4 x	3/8	400
CI481222W	3/8 x	1/4	200
Casquillo azul CI480821WB	1/4 x	1/8	500



Conectores **Superseal** en pulgadas

Para utilizar con tuberías de acero inoxidable

Para tubos de 1/4" a 3/8" de diámetro exterior se ofrece la gama SI de conectores de empuje en pulgadas. Superseal es un conector especial diseñado para proporcionar agarre adicional en los tubos de acero inoxidable.

El diseño de Superseal incluye un casquillo con dientes de acero inoxidable totalmente moldeados similar al diseño estándar de Super Speedfit, pero que incorpora una tuerca de accionamiento manual y una arandela plástica en forma de cuña para aplicar presión adicional al casquillo y los sellos de la junta tórica doble. Esto garantiza que los dientes del casquillo sujeten totalmente el tubo para proporcionar agarre, mientras que al mismo tiempo comprimen las juntas tóricas para aumentar aún más el sellado.

Como otros conectores de John Guest, Superseal es adecuado para líquidos potables y otras aplicaciones en el ámbito de la calidad alimentaria.

En la página 24 se incluye información técnica detallada. Los precios están sujetos a cambios sin previo aviso.

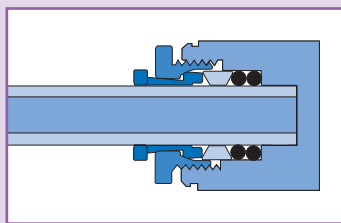
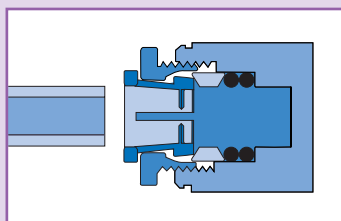

CODO SUPERSEAL - SPEEDFIT



NRO. DE PIEZA	Ø EXT. SUPERSEAL	Ø EXT. SPEEDFIT	CANT. P. CAJA
SI030812S	1/4	3/8	150
SM030808S	5/16	5/16	200
SI031012S	5/16	3/8	150
SI031210S	3/8	5/16	150
SI031212S	3/8	3/8	150

CODO SUPERSEAL - SUPERSEAL



NRO. DE PIEZA	Ø EXT. SUPERSEAL	Ø EXT. SPEEDFIT	CANT. P. CAJA
SM400808S	5/16	5/16	150
SI401210S	3/8	5/16	150
SI401212S	3/8	3/8	150

UNIÓN SUPERSEAL - SPEEDFIT



NRO. DE PIEZA	Ø EXT. SUPERSEAL	Ø EXT. SPEEDFIT	CANT. P. CAJA
SM040808S	5/16	5/16	200
SI041012S	5/16	3/8	200
SI041016S	5/16	1/2	200
SI041210S	3/8	5/16	200
SI041212S	3/8	3/8	150

UNIÓN SUPERSEAL - SUPERSEAL



NRO. DE PIEZA	Ø EXT. SUPERSEAL	CANT. P. CAJA
SM410808E	5/16	200

CONECTOR MACHO ROSCA BSPT



NRO. DE PIEZA	Ø EXT. SUPERSEAL	ROSCA BSPT	CANT. P. CAJA
SM010802S	5/16	x 1/4	200

CONECTOR MACHO ROSCA BSPP



NRO. DE PIEZA	Ø EXT. SUPERSEAL	ROSCA BSPP	CANT. P. CAJA
SM010812S	5/16	x 1/4	200

CONECTOR HEMBRA RASCO MFL



NRO. DE PIEZA	Ø EXT. SUPERSEAL	ROSCA MFL	CANT. P. CAJA
SM0108F4S	5/16	x 1/4	200

CONECTOR A MANGUERA



NRO. DE PIEZA	Ø EXT. SUPERSEAL	Ø INT. MANGUERA	CANT. P. CAJA
SI270808S	1/4	1/4	300
SI271008S	5/16	1/4	250
SI271208S	3/8	1/4	200

CONECTOR CURVA SUPERSEAL - SPEEDFIT



NRO. DE PIEZA	Ø EXT. SUPERSEAL	Ø EXT. SPEEDFIT	CANT. P. CAJA
SM420808S	5/16	5/16	100
SI421012S	5/16	3/8	100
SI421210S	3/8	5/16	100
SI421212S	3/8	3/8	100

LLAVE



NRO. DE PIEZA	SIZE	CANT. P. CAJA
SPAN1	5/16 & 3/8	200

SPAN1 5/16 & 3/8 200

Conectores de Bronce en pulgadas

Diseñados para su uso en máquinas de elaboración de café, máquinas dispensadoras de bebidas y máquinas expendedoras. Los conectores están fabricados en bronce con un casquillo de polipropileno y una junta tórica de EPDM aprobada para uso con alimentos.

NO son adecuados para uso con aire comprimido.

Presiones y temperaturas

Agua	Máx.	150 psi a 70°F	(Max. 10 bar a 20°C)
	Máx.	60 psi a 140°F	(Max. 4 bar a 60°C)
	Min.	33°F/1°C	

En la página 24 se incluye información técnica detallada.
Los precios están sujetos a cambios sin previo aviso.



CONECTOR HEMBRA FLARE DE BRONCE

ROSCA FFL



NRO. DE PIEZA	Ø EXT. TUBO	ROSCA FFL	CANT. P. CAJA
---------------	-------------	-----------	---------------

MI4508F4S	1/4 x 1/4	200	
Sin Plomo *MI4508F4SLF	1/4 x 1/4	200	
MI4512F4S	3/8 x 1/4	200	
Sin Plomo *MI4512F4SLF	3/8 x 1/4	200	
MI4512F6S	3/8 x 3/8	100	
Sin Plomo *MI4512F6SLF	3/8 x 3/8	100	

1/4 (FFL) corresponde a 7/16 - 20 UNF3/8 3/8
(FFL) corresponde a 5/8 - 18 UNF

*Contiene menos de 0.25% de plomo.

CONECTOR HEMBRA DE BRONCE (MANGUERA DE JARDÍN)

ROSCA NH (Manguera nacional)



NRO. DE PIEZA	Ø EXT. TUBO	ROSCA N.H.	CANT. P. CAJA
---------------	-------------	------------	---------------

NC2258	3/8 x 3/4 - 11.5 NH	100	
--------	---------------------	-----	--

CONECTOR HEMBRA DE POLIPROPILENO Y BRONCE

ROSCA BSPP



NRO. DE PIEZA	Ø EXT. TUBO	ROSCA BSPP	CANT. P. CAJA
---------------	-------------	------------	---------------

NC2145	1/4 x 3/4	150	
Sin Plomo *NC2145LF	1/4 x 3/4	150	
NC2249	3/8 x 3/4	100	
Sin Plomo *NC2249LF	3/8 x 3/4	100	

CONECTOR HEMBRA DE BRONCE (MANGUERA DE JARDÍN)

ROSCA NH (Manguera nacional)



NRO. DE PIEZA	Ø EXT. TUBO	ROSCA N.H.	CANT. P. CAJA
---------------	-------------	------------	---------------

NC2098	1/4 x 3/4 - 11.5 NH	100	
Sin Plomo *NC2098LF	1/4 x 3/4 - 11.5 NH	100	

El codo espiga lisa que aparece en la página 5 proporcionará una instalación impecable a 90°. El tubo puede colocarse en cualquier dirección

*Contiene menos de 0.25% de plomo.

Conectores de tamaño métrico a pulgadas

UNIÓN



NRO. DE PIEZA	Ø EXT. TUBO	Ø EXT. TUBO	CANT. P. CAJA
---------------	-------------	-------------	---------------

NC462	15mm - 1/2"	400	
-------	-------------	-----	--

ADAPTADOR ESPIGA A TUBO



NRO. DE PIEZA	Ø EXT. ESPIGA	Ø EXT. TUBO	CANT. P. CAJA
---------------	---------------	-------------	---------------

NC2164	15mm - 3/8"	200	
NC2173	1/2" - 15mm	100	
NC908	1/2" - 18mm	100	

ESPIGA TUBO A MANGUERA



NRO. DE PIEZA	Ø EXT. ESPIGA	Ø INT. MANGUERA	CANT. P. CAJA
---------------	---------------	-----------------	---------------

NC932	15mm - 1/2"	150	
-------	-------------	-----	--

CONECTOR A MANGUERA



NRO. DE PIEZA	Ø EXT. ESPIGA	Ø INT. MANGUERA	CANT. P. CAJA
---------------	---------------	-----------------	---------------

NC448	15mm - 1/2"	1000	
-------	-------------	------	--

ADAPTADOR EN TE



NRO. DE PIEZA	Ø EXT. EXTREMO DEL TUBO	Ø EXT. RACOR DEL TUBO	CANT. CAJA
---------------	-------------------------	-----------------------	------------

NC869	15mm - 3/8"	400	
-------	-------------	-----	--

ADAPTADOR ESPIGA A ESPIGA



NRO. DE PIEZA	Ø EXT. ESPIGA	Ø INT. ESPIGA	CANT. P. CAJA
---------------	---------------	---------------	---------------

NC478	15mm - 3/8"	150	
-------	-------------	-----	--

UNIÓN DOBLE SUPERSEAL X SPEEDFIT



NRO. DE PIEZA	Ø EXT. SUPERSEAL	Ø EXT. SPEEDFIT	CANT. P. CAJA
---------------	------------------	-----------------	---------------

NC2301	15mm - 1/2"	80	
--------	-------------	----	--

Conectores métricos de polipropileno

Para los tubos de 8 mm a 15 mm de diámetro exterior se ofrece la gama PPM de conectores de empuje métricos. Los conectores se fabrican en polipropileno blanco con juntas tóricas de EPDM. Han sido desarrollados para satisfacer necesidades de compatibilidad para una amplia gama de aplicaciones.

La gama PPM NO es adecuada para aplicaciones con aire comprimido. Para estos casos, recomendamos la gama PM que aparece en las páginas 15 a 17.

Presiones y temperaturas de trabajo

Agua	Máx.	150 psi a 70°F	(Max. 10 bares a 20°C)
	Máx.	60 psi a 140°F	(Max. 4 bares a 60°C)
	Min.	33°F/1°C	

En la página 24 se incluye información técnica detallada.
Los precios están sujetos a cambios sin previo aviso.



UNIÓN



NRO. DE PIEZA	Ø EXT. TUBO	CANT. P. CAJA
PPM0408W	8	300
PPM0412W	12	100

CODO



NRO. DE PIEZA	Ø EXT. TUBO	CANT. P. CAJA
PPM0308W	8	300
PPM0312W	12	100

TE IGUAL



NRO. DE PIEZA	Ø EXT. TUBO	CANT. P. CAJA
PPM0208W	8	200
PPM0212W	12	80

UNIÓN REDUCIDA



NRO. DE PIEZA	Ø EXT. TUBO	Ø EXT. TUBO	CANT. P. CAJA
PPM201512W	15	- 12	100

CODO ESPIGA



NRO. DE PIEZA	Ø EXT. ESPIGA	Ø EXT. TUBO	CANT. P. CAJA
PPM220808W	8	- 8	400
PPM221212W	12	- 12	100

REDUCTOR



NRO. DE PIEZA	Ø EXT. ESPIGA	Ø EXT. TUBO	CANT. P. CAJA
PPM061512W	15	- 12	150

TAPÓN



NRO. DE PIEZA	Ø EXT. ESPIGA	CANT. P. CAJA
PPM0808W	8	500

DIVISOR



NRO. DE PIEZA	Ø EXT. TUBO	CANT. P. CAJA
PPM2312W	12	80

Los adaptadores para convertir a tamaños en pulgadas aparecen en la página 13.



Conectores métricos de acetal

Para los tubos de 4 mm a 28 mm de diámetro exterior se ofrece la gama PM de conectores de empuje métricos. Los conectores se fabrican en acetal copolímero negro con juntas tóricas de nitrilo aprobadas para el uso con alimentos. Se fabrican especialmente para productos alimenticios y líquidos potables, son apropiadas de igual modo para aplicaciones con aire y gases inertes y por lo tanto pueden utilizarse con líneas de CO₂, aplicaciones neumáticas y vacío.

En la página 24 se incluye información técnica detallada.
Los precios están sujetos a cambios sin previo aviso.



CONECTOR MACHO ROSCA BSPT



NRO. DE PIEZA	Ø EXT. TUBO (mm)	ROSCA BSPT (pulg.)	CANT. P. CAJA
PM010401E	4 x	1/8	500
PM010402E	4 x	1/4	500
PM010501E	5 x	1/8	500
PM010502E	5 x	1/4	500
PM010601E	6 x	1/8	500
PM010602E	6 x	1/4	500
PM010801E	8 x	1/8	400
PM010802E	8 x	1/4	400
PM010803E	8 x	3/8	300
PM011002E	10 x	1/4	250
PM011003E	10 x	3/8	250
PM011004E	10 x	1/2	200
PM011203E	12 x	3/8	150
PM011204E	12 x	1/2	150

CODO



NRO. DE PIEZA	Ø EXT. TUBO (mm)	CANT. P. CAJA
PM0204E	4	400
PM0205E	5	400
PM0206E	6	300
PM0208E	8	200
PM0210E	10	100
PM0212E	12	50
PM0215E	15	50
PM0218E	18	30
PM0222E	22	20
PM0228E	28	10

CODO



NRO. DE PIEZA	Ø EXT. TUBO (mm)	CANT. P. CAJA
PM0304E	4	500
PM0305E	5	500
PM0306E	6	400
PM0308E	8	300
PM0310E	10	200
PM0312E	12	100
PM0315E	15	50
PM0318E	18	50
PM0322E	22	30
PM0328E	28	20

UNIÓN



NRO. DE PIEZA	Ø EXT. TUBO (mm)	CANT. P. CAJA
PM0404E	4	500
PM0405E	5	500
PM0406E	6	400
PM0408E	8	300
PM0410E	10	200
PM0412E	12	100
PM0415E	15	100
PM0418E	18	50
PM0422E	22	50
PM0428E	28	25

CONECTOR MACHO ROSCA BSPP



NRO. DE PIEZA	Ø EXT. TUBO (mm)	ROSCA BSPP (pulg.)	CANT. P. CAJA
PM010411E	4 x	1/8	500
PM010412E	4 x	1/4	500
PM010511E	5 x	1/8	500
PM010512E	5 x	1/4	500
PM010611E	6 x	1/8	500
PM010612E	6 x	1/4	500
PM010811E	8 x	1/8	400
PM010812E	8 x	1/4	400
PM010813E	8 x	3/8	300
PM011012E	10 x	1/4	250
PM011013E	10 x	3/8	250
PM011014E	10 x	1/2	200
PM011213E	12 x	3/8	150
PM011214E	12 x	1/2	150
PM011514E	15 x	1/2	150
PM011814E	18 x	1/2	70
PM012216E	22 x	3/4	50

NRO. DE PIEZA	Ø EXT. TUBO (mm)	ROSCA NPFT (pulg.)	CANT. P. CAJA
PM010622E	6 x	1/4	500

ADAPTADOR ESPIGA ROSCA BSPT



NRO. DE PIEZA	Ø EXT. TUBO (mm)	ROSCA BSPT (pulg.)	CANT. P. CAJA
PM050401E	4 x	1/8	500
PM050402E	4 x	1/4	500
PM050501E	5 x	1/8	500
PM050502E	5 x	1/4	500
PM050601E	6 x	1/8	500
PM050602E	6 x	1/4	500
PM050801E	8 x	1/8	500
PM050802E	8 x	1/4	500
PM050803E	8 x	3/8	300
PM051002E	10 x	1/4	300
PM051003E	10 x	3/8	300
PM051004E	10 x	1/2	200
PM051203E	12 x	3/8	200
PM051204E	12 x	1/2	150

ADAPTADOR ESPIGA ROSCA BSPP



NRO. DE PIEZA	Ø EXT. TUBO (mm)	ROSCA BSPP (pulg.)	CANT. P. CAJA
PM050411E	4 x	1/8	500
PM050412E	4 x	1/4	500
PM050511E	5 x	1/8	500
PM050512E	5 x	1/4	500
PM050611E	6 x	1/8	500
PM050612E	6 x	1/4	500
PM050811E	8 x	1/8	500
PM050812E	8 x	1/4	500
PM050813E	8 x	3/8	300
PM051012E	10 x	1/4	300
PM051013E	10 x	3/8	300
PM051014E	10 x	1/2	200
PM051213E	12 x	3/8	200
PM051214E	12 x	1/2	150
PM051513E	15 x	3/8	150
PM051514E	15 x	1/2	100
PM051814E	18 x	1/2	100
PM052214E	22 x	1/2	100
PM052216E	22 x	3/4	50

REDUCTOR



NRO. DE PIEZA	Ø EXT. ESPIGA (mm)	Ø EXT. TUBO (mm)	CANT. P. CAJA
PM060504E	5	- 4	500
PM060604E	6	- 4	500
PM060605E	6	- 5	500
PM060804E	8	- 4	500
PM060805E	8	- 5	500
PM060806E	8	- 6	500
PM061006E	10	- 6	400
PM061008E	10	- 8	400
PM061208E	12	- 8	300
PM061210E	12	- 10	250
PM061510E	15	- 10	200
PM061512E	15	- 12	100
PM061815E	18	- 15	100
PM062215E	22	- 15	50
PM062218E	22	- 18	50
PM062815E	28	- 15	50
PM062822E	28	- 22	50

TAPÓN



NRO. DE PIEZA	Ø EXT. ESPIGA (mm)	CANT. P. CAJA
PM0804R	4	1000
PM0805R	5	1000
PM0806R	6	500
PM0808R	8	500
PM0810R	10	400
PM0812R	12	300

R: indica tapón de color rojo.

CODO GIRATORIO ROSCA BSPT



NRO. DE PIEZA	Ø EXT. TUBO (mm)	ROSCA BSPT (pulg.)	CANT. P. CAJA
PM090401E	4	x 1/8	400
PM090402E	4	x 1/4	300
PM090501E	5	x 1/8	400
PM090502E	5	x 1/4	300
PM090601E	6	x 1/8	300
PM090602E	6	x 1/4	200
PM090801E	8	x 1/8	200
PM090802E	8	x 1/4	200
PM090803E	8	x 3/8	200
PM091002E	10	x 1/4	100
PM091003E	10	x 3/8	100
PM091004E	10	x 1/2	100
PM091203E	12	x 3/8	50
PM091204E	12	x 1/2	50

CODO GIRATORIO ROSCA BSPP



NRO. DE PIEZA	Ø EXT. TUBO (mm)	ROSCA BSPP (pulg.)	CANT. P. CAJA
PM090411E	4	x 1/8	400
PM090412E	4	x 1/4	300
PM090511E	5	x 1/8	400
PM090512E	5	x 1/4	300
PM090611E	6	x 1/8	300
PM090612E	6	x 1/4	200
PM090811E	8	x 1/8	200
PM090812E	8	x 1/4	200
PM090813E	8	x 3/8	200
PM091012E	10	x 1/4	100
PM091013E	10	x 3/8	100
PM091014E	10	x 1/2	100
PM091213E	12	x 3/8	50
PM091214E	12	x 1/2	50

RACOR EN TE GIRATORIA ROSCA BSPT



NRO. DE PIEZA	Ø EXT. TUBO (mm)	ROSCA BSPT (pulg.)	CANT. P. CAJA
PM100401E	4	x 1/8	200
PM100402E	4	x 1/4	200
PM100501E	5	x 1/8	200
PM100502E	5	x 1/4	200
PM100601E	6	x 1/8	200
PM100602E	6	x 1/4	200
PM100801E	8	x 1/8	100
PM100802E	8	x 1/4	100
PM100803E	8	x 3/8	100
PM101002E	10	x 1/4	100
PM101003E	10	x 3/8	100
PM101004E	10	x 1/2	100
PM101203E	12	x 3/8	50
PM101204E	12	x 1/2	50

RACOR EN TE GIRATORIA ROSCA BSPP



NRO. DE PIEZA	Ø EXT. TUBO (mm)	ROSCA BSPP (pulg.)	CANT. P. CAJA
PM100411E	4	x 1/8	200
PM100412E	4	x 1/4	200
PM100511E	5	x 1/8	200
PM100512E	5	x 1/4	200
PM100611E	6	x 1/8	200
PM100612E	6	x 1/4	200
PM100811E	8	x 1/8	100
PM100812E	8	x 1/4	100
PM100813E	8	x 3/8	100
PM101012E	10	x 1/4	100
PM101013E	10	x 3/8	100
PM101014E	10	x 1/2	50
PM101213E	12	x 3/8	50
PM101214E	12	x 1/2	50

TE MACHO LATERAL GIRATORIO

ROSCA BSPT



NRO. DE PIEZA	Ø EXT. TUBO (mm)	ROSCA BSPT (pulg.)	CANT. P. CAJA
PM110401E	4	x 1/8	200
PM110402E	4	x 1/4	200
PM110501E	5	x 1/8	200
PM110502E	5	x 1/4	200
PM110601E	6	x 1/8	200
PM110602E	6	x 1/4	200
PM110801E	8	x 1/8	100
PM110802E	8	x 1/4	100
PM110803E	8	x 3/8	100
PM111002E	10	x 1/4	100
PM111003E	10	x 3/8	100
PM111004E	10	x 1/2	100
PM111203E	12	x 3/8	50
PM111204E	12	x 1/2	50

TE MACHO LATERAL GIRATORIO

ROSCA BSPP



NRO. DE PIEZA	Ø EXT. TUBO (mm)	ROSCA BSPP (pulg.)	CANT. P. CAJA
PM110411E	4	x 1/8	200
PM110412E	4	x 1/4	200
PM110511E	5	x 1/8	200
PM110512E	5	x 1/4	200
PM110611E	6	x 1/8	200
PM110612E	6	x 1/4	200
PM110811E	8	x 1/8	100
PM110812E	8	x 1/4	100
PM110813E	8	x 3/8	100
PM111012E	10	x 1/4	100
PM111013E	10	x 3/8	100
PM111014E	10	x 1/2	50
PM111213E	12	x 3/8	50
PM111214E	12	x 1/2	50

Adaptabilidad de John Guest

Los productos **Super Speedfit** pueden acoplarse para formar conectores totalmente nuevos.

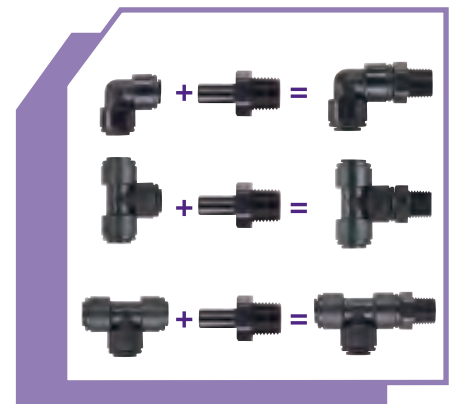

PASATABIQUES

NRO. DE PIEZA	Ø EXT. TUBO (mm)	Diám. del orificio de montaje (mm)	CANT. P. CAJA
PM1204E	4	16,5	200
PM1205E	5	16,5	200
PM1206E	6	16,5	200
PM1208E	8	21,0	100
PM1210E	10	21,0	100
PM1212E	12	26,5	50

ALARGADOR

NRO. DE PIEZA	Ø EXT. ESPIGA (mm)	Ø EXT. TUBO (mm)	CANT. P. CAJA
PM130405E	4	5	500

UNIÓN REDUCIDA

NRO. DE PIEZA	Ø EXT. TUBO (mm)	Ø EXT. TUBO (mm)	CANT. P. CAJA
PM200604E	6	4	400
PM200804E	8	4	300
PM200806E	8	6	200
PM201004E	10	4	200
PM201006E	10	6	200
PM201008E	10	8	200
PM201208E	12	8	100
PM201210E	12	10	100

CODO REDUCIDA

NRO. DE PIEZA	Ø EXT. TUBO (mm)	Ø EXT. TUBO (mm)	CANT. P. CAJA
PM210604E	6	4	400
PM210804E	8	4	300
PM210806E	8	6	200
PM211004E	10	4	200
PM211006E	10	6	200
PM211008E	10	8	200
PM211208E	12	8	100
PM211210E	12	10	100

CODO ESPIGA

NRO. DE PIEZA	Ø EXT. ESPIGA (mm)	Ø EXT. TUBO (mm)	CANT. P. CAJA
PM220404E	4	4	500
PM220505E	5	5	500
PM220606E	6	6	500
PM220808E	8	8	400
PM221010E	10	10	200
PM221212E	12	12	100
PM221515E	15	15	100
PM221818E	18	18	50
PM222222E	22	22	50

DIVISOR DE DOS VÍAS

NRO. DE PIEZA	Ø EXT. TUBO (mm)	CANT. P. CAJA
PM2304E	4	300
PM2308E	8	100
PM2310E	10	100
PM2315E	15	50

TE DE REDUCIDA

NRO. DE PIEZA	Ø EXT. EXTREMO DEL TUBO (mm)	Ø EXT. RACOR DEL TUBO (mm)	CANT. CAJA
PM3018AE	18	15	30
PM3022AE	22	15	20

CONECTOR DE MEZCLADORA

NRO. DE PIEZA	Ø EXT. TUBO (mm)	ROSCA (pulg.)	CANT. P. CAJA
PM450411E	4	1/8 BSPP	500
PM450611E	6	1/8 BSPP	500
PM450612E	6	1/4 BSPP	300
PM450812E	8	1/4 BSPP	300
PM450813E	8	3/8 BSPP	200
PM4508F4S	8	1/4 FFL	300
PM4508C5S	8	1/2-16UN	300
PM451015FE	10	5/8 BSPP	100
PM451215FE	12	5/8 BSPP	150

ESPIGA TUBO A MANGUERA

NRO. DE PIEZA	Ø EXT. ESPIGA (mm)	Ø INT. MANGUERA (mm)	CANT. P. CAJA
PM250604E	6	4	500
PM250806E	8	6	500
PM251008E	10	8	300

TAPÓN

NRO. DE PIEZA	Ø EXT. TUBO (mm)	CANT. P. CAJA
PM4612E	12	250
PM4615E	15	200
PM4622E	22	80

CODO ROSCA MACHO

NRO. DE PIEZA	Ø EXT. TUBO (mm)	ROSCA NPTF (pulg.)	CANT. P. CAJA
PM480621E	6	x 1/8	500
PM480622E	6	x 1/4	400
PM480623E	6	x 3/8	300

CONECTOR DE AJUSTE

NRO. DE PIEZA	Ø EXT. TUBO (mm)	Ø EXT. TUBO (mm)	CANT. P. CAJA
NC657	12	8	1000

CONECTOR EN U

NRO. DE PIEZA	Ø EXT. TUBO (mm)	CANT. P. CAJA
PMUB15E	15	50

Los accesorios para los conectores PM aparecen en la página 23.



Válvulas Angular en Polipropileno en Pulgadas



La gama ASVPP de válvulas angular en pulgadas se ofrece en polipropileno blanco con juntas tóricas de EPDM aprobadas para uso con alimentos. Nuestra válvula angular con adaptador es la conexión entre la válvula y el tubo vertical, a la tubería de suministro de agua principal, para aplicaciones en osmosis inversa, sistemas de filtración, máquinas automáticas de café, máquinas para fabricar hielo y mucho más. Comuníquese con nuestro departamento de soporte técnico para asesorarse sobre el uso con otros líquidos potables.

Las válvulas no deben utilizarse con aire comprimido, gases explosivos, alcoholes de petróleo y otros combustibles, o para sistemas de calefacción.

SÓLO PARA USO CON SUMINISTRO DE AGUA.

Presiones y temperaturas

Agua	Máx.	150 psi a 70°F	(Max. 10 bares a 20°C)
	Máx.	60 psi a 140°F	(Max. 4 bares a 60°C)
	Min.	33°F/1°C	

En la página 24 se incluye información técnica detallada.
Los precios están sujetos a cambios sin previo aviso.

VÁLVULA ANGULAR CON ADAPTADOR •



NRO. DE PIEZA	COMPRESIÓN DE ROSCA MACHO	COMPRESIÓN DE ROSCA HEMBRA	Ø EXT. TUBO	CANT. POR BOLSA	CANT. P. CAJA
ASVPP1	3/8"	x 3/8"	x 1/4"	1	30
*ASVPP1LF	3/8"	x 3/8"	x 1/4"	1	30
ASVPP2	3/8"	x 3/8"	x 3/8"	1	30
*ASVPP2LF	3/8"	x 3/8"	x 3/8"	1	30

VÁLVULA ANGULAR CON ADAPTADOR (CON ROSCA ADAPTADORA) •



NRO. DE PIEZA	ROSCA MACHO NPS HEMBRA	COMPRESIÓN DE ROSCA	Ø EXT. TUBO	CANT. POR BOLSA	CANT. P. CAJA
ASVPP5	1/2"	x 3/8"	x 1/4"	1	40
*ASVPP5LF	1/2"	x 3/8"	x 1/4"	1	40
ASVPP6	1/2"	x 3/8"	x 3/8"	1	30
*ASVPP6LF	1/2"	x 3/8"	x 3/8"	1	20



*El adaptador de conversión puede enroscarse para cualquier lado de la válvula para efectuar configuración de 1/2"x1/2" NPS o compresión 3/8"x3/8".

Cómo conectar la válvula de adaptador del tapón en ángulo.

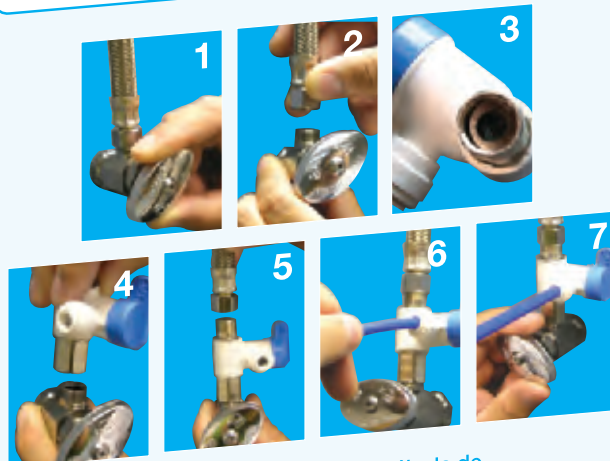

1. Cierre el suministro de agua en la válvula de suministro de bronce o cromo.
2. Desconecte el tubo vertical de la válvula de suministro de bronce o cromo.
3. Asegúrese de que la junta de sellado esté completamente asentada en la rosca hembra de la válvula angular.
4. Instale la válvula de angular con adaptador en la válvula de suministro.
5. Conecte el tubo vertical a la válvula angular con adaptador.
6. Introduzca completamente la tubería en el lado Speedfit de la válvula.
7. Abra las válvulas y verifique que no haya filtraciones.

1. Válvulas de un cuarto (1/4) de vuelta. Estas válvulas han sido diseñadas para permitir el servicio temporero de equipos con surtidor de servicio vertical y sólo deben utilizarse en la posición completamente abierta o completamente cerrada.
2. NO UTILICE ESTAS VÁLVULAS:
 - En una posición parcialmente abierta para controlar el flujo
 - Para proporcionar un cese permanente.
 - Sin tubos empalmados correctamente o conectado (o conexiones selladas de rosca).
 - Como un grifo o "llave".
3. Válvulas de un cuarto de vuelta. Se indican con esta contramarca (•)

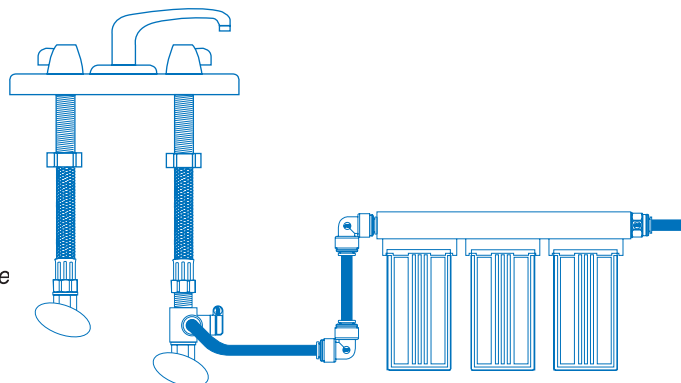

Válvula de Cierre de polipropileno en pulgadas



La gama PPSV de válvula de cierre se ofrece para los tubos de 1/4" y 3/8" de diámetro exterior, se fabrican con polipropileno y se adaptan a juntas tóricas de EPDM. El polipropileno tiene la ventaja de ser más resistente a los productos químicos que el acetal.

Las válvulas son para uso con agua potable. Para utilizarlas con otros líquidos potables, comuníquese con nuestro departamento de soporte técnico para asesorarse.

Las válvulas no deben utilizarse con aire comprimido, gases explosivos, alcoholes de petróleo y otros combustibles, o para sistemas de calefacción.

Presiones y temperaturas

Agua	Máx.	150 psi a 70°F	(Max. 10 bar a 20°C)
	Máx.	60 psi a 140°F	(Max. 4 bar a 60°C)
	Min.	33°F/1°C	

En la página 24 se incluye información técnica detallada.
Los precios están sujetos a cambios sin previo aviso.



SPEEDFIT A MACHO • ROSCA NPTF



NRO. DE PIEZA	Ø EXT. TUBO	ROSCA NPTF	CANT. P. CAJA
PPSV010822W	1/4	x 1/4	200
PPSV011223W	3/8	x 3/8	100

SPEEDFIT A SPEEDFIT •



NRO. DE PIEZA	Ø EXT. TUBO	CANT. P. CAJA	
PPSV040808W	1/4	200	6.72
PPSV041212W	3/8	100	7.10

SPEEDFIT TO HEMBRA • ROSCA NPTF



NRO. DE PIEZA	Ø EXT. TUBO	ROSCA NPTF	CANT. P. CAJA
PPSV500822W	1/4	x 1/4	200
PPSV501222W	3/8	x 1/4	100

Válvulas paso en ángulo de acetal

Las válvulas de tapón en ángulo de John Guest se fabrican en acetal con juntas tóricas de EPDM. Incluyen una sola válvula anti retorno y una válvula esférica cromada con giro de 1/4.

Las válvulas son para uso con agua potable. Para utilizarlas con otros líquidos potables, comuníquese con nuestro departamento de soporte técnico para asesorarse.

Las válvulas no deben utilizarse con aire comprimido, gases explosivos, alcoholes de petróleo y otros combustibles, o para sistemas de calefacción.

Presiones y temperaturas

Agua	Máx.	174 psi a 68°F	(Max. 12 bar a 20°C)
	Máx.	87 psi a 149°F	(Max. 6 bar a 65°C)

VÁLVULA EN T DE ACETAL •



NRO. DE PIEZA	Ø EXT. TUBO	Ø EXT. RACOR DEL TUBO	CANT. P. CAJA
ASV3	15mm	- 1/4	30
ASV4	15mm	- 3/8	25

- Válvulas de un cuarto (¼) de vuelta. Estas válvulas han sido diseñadas para permitir el servicio temporero de equipos con surtidor de servicio vertical y sólo deben utilizarse en la posición completamente abierta o completamente cerrada.
- NO UTILICE ESTAS VÁLVULAS:
 - En una posición parcialmente abierta para controlar el flujo
 - Para proporcionar un cese permanente.
 - Sin tubos empalmados correctamente o conectado (o conexiones selladas de rosca).
 - Como un grifo o "llave"
- Válvulas de un cuarto de vuelta. Se indican con esta contramarca (•)

Válvula de Cierre de acetil en pulgadas

La gama PISV de válvulas de cierre en pulgadas está disponible para tubos de 3/8" y 1/2" de diámetro exterior. La válvula se fabrica en acetil copolímero gris con una junta tórica de nitrilo.

Las válvulas están disponibles con manijas cortas y largas para accionar un cierre de 1/4.

Específicamente diseñadas para aire comprimido y líquidos potables, las válvulas son ideales para líneas de CO2 en máquinas dispensadoras de bebidas y aplicaciones neumáticas.

Presiones y temperaturas

Aire		150 psi a -4°F (10 bar a -20°C)
Aire/Líquidos Potables	Max.	150 psi a 33°F (10 bar a 1°C)
	Max.	150 psi a 73°F (10 bar a 23°C)
	Max.	100 psi a 150°F (7 bar a 65°C)

Es la responsabilidad del cliente asegurar que instalación de los conectores de John Guest con aplicaciones de CO2 estén de acuerdo a la norma de la industria y guías de seguridad gubernamentales.

En la página 24 se incluye información técnica detallada. Los precios están sujetos a cambios sin previo aviso.

VÁLVULA DE CIERRE • MANIJA CORTA



NRO. DE PIEZA	Ø EXT. TUBO	CANT. P. CAJA
PISV0412CS	3/8	100

VÁLVULA DE PASO • MANIJA LARGA



NRO. DE PIEZA	Ø EXT. TUBO	CANT. P. CAJA
PISV0412S	3/8	100
PISV0416S	1/2	50

ABRAZADERA DE MONTAJE



NRO. DE PIEZA	TOMAÑO	CANT. P. CAJA
SVMC-06	6mm	200
SVMC-10	10mm	100

- Válvulas de un cuarto (1/4) de vuelta. Estas válvulas han sido diseñadas para permitir el servicio temporero de equipos con surtidor de servicio vertical y sólo deben utilizarse en la posición completamente abierta o completamente cerrada.
- NO UTILICE ESTAS VÁLVULAS:
 - En una posición parcialmente abierta para controlar el flujo
 - Para proporcionar un cese permanente.
 - Sin tubos empalmados correctamente o conectado (o conexiones selladas de rosca).
 - Como un grifo o "llave".
- Válvulas de un cuarto de vuelta. Se indican con esta contramarca (•)

La abrazadera de montaje está diseñada para proporcionar un agarre bien firme. Es necesario efectuar un giro para retirar la válvula. La abrazadera puede utilizarse con cualquier válvula de cierre. Cuando se utiliza con la versión de manija corta, las válvulas pueden agruparse.

Disponible para válvulas de 3/8" de diámetro exterior.

Válvulas de derivación y de Cierre de acetil

Específicamente fabricadas en acetil blanco con juntas tóricas de EPDM, estas válvulas han sido desarrolladas para cumplir con los requisitos de los mercados vehículos recreativos (RV) y remolques (MH). Las válvulas son sólo para agua caliente y fría.

Presiones y temperaturas

Agua	Máx.	150 psi a 70°F (Max. 10 bar a 20°C)
	Máx.	60 psi a 140°F (Max. 4 bar a 60°C)
	Min.	33°F/1°C

En la página 36 se incluye información técnica detallada. No se incluye en el catálogo de IAPMO.

VÁLVULA DE CIERRE RECTA •



NRO. DE PIEZA	Tamaño de tubería de cobre (CTS)	CANT. P. CAJA
NC2390	1/2	25

VÁLVULAS DE DERIVACIÓN •



NRO. DE PIEZA	Tamaño de tubería de cobre (CTS)	CANT. P. CAJA
NC2391-RH	1/2	25
NC2391-LH	1/2	25

- Válvulas de un cuarto (1/4) de vuelta. Estas válvulas han sido diseñadas para permitir el servicio temporero de equipos con surtidor de servicio vertical y sólo deben utilizarse en la posición completamente abierta o completamente cerrada.
- NO UTILICE ESTAS VÁLVULAS:
 - En una posición parcialmente abierta para controlar el flujo
 - Para proporcionar un cese permanente.
 - Sin tubos empalmados correctamente o conectado (o conexiones selladas de rosca).
 - Como un grifo o "llave".
- Válvulas de un cuarto de vuelta. Se indican con esta contramarca (•)

Tuberías de polietileno en pulgadas

TUBERÍAS LLDPE

La gama PE de John Guest de tuberías plásticas se fabrica en polietileno lineal de baja densidad para aplicaciones con agua fría y con agua caliente discontinuas. Nuestras tuberías están fabricadas con materiales que cumplen con las normas de la Administración de Drogas y Alimentos y están certificadas por las Normas Internacionales NSF 51 y 61. Las tuberías LLDPE de John Guest proporcionan una resistencia excelente a las grietas producidas por la tensión ambiental según la evaluación de ASTM D-1693 (10% IGEPAL).



Las tuberías de polietileno de John Guest están diseñadas para ser utilizadas con conectores de empuje Super Speedfit de John Guest, las válvulas de cierre de John Guest y prácticamente todos los conectores de tuberías estándar.

Los precios están sujetos a cambios sin previo aviso.

PRECIO POR ROLLO

NRO. DE PIEZA	Ø EXT.	LARGO DE LOS ROLLOS	CANT. P. CAJA	
PE-08-BI-0500F-N	1/4"	500 FT	2	
PE-08-BI-1000F-N	1/4"	1000FT	1	
PE-10-CI-0500F-N	5/16"	500 FT	1	
PE-12-EI-0500F-N	3/8"	500 FT	1	
PE-16-GI-0250F-N	1/2"	250 FT	1	
PE-04025-0100M-N	4mm	100m	2	
PE-0604-0100M-N	6mm	100m	2	
PE-0806-100M-N	8mm	100m	2	
PE-1007-100M-N	10mm	100m	1	
PE-1209-100M-N	12mm	100m	1	
PE-15115-0100M-B	15mm	100m	2	

N indica color natural. Para solicitar otros colores, utilice los sufijos:

B=Azul, R=Rojo, E=Negro, W=Blanco, G=Verde, Y=Amarillo, O=Naranja, and V=Violeta



COLORES DISPONIBLES

COLOR DEL SUFJO		TAMAÑOS									
		1/4"	5/16"	3/8"	1/2"	4mm	6mm	8mm	10mm	12mm	15mm
N	NATURAL	✓	✓	✓	✓	✓	✓	✓	✓	✓	○
W	BLANCO	✓	○	✓	✓	○	○	✓	○	○	○
B	AZUL	✓	✓	✓	✓	✓	✓	✓	✓	✓	✓
E	*NEGRO	✓	✓	✓	✓	✓	✓	✓	✓	✓	○
R	ROJO	✓	✓	✓	✓	✓	✓	✓	✓	✓	✓
O	NARANJA	✓	○	✓	○	○	○	○	○	○	○
V	VIOLETA	✓	○	✓	○	○	○	○	○	○	○
G	VERDE	✓	○	✓	○	○	○	○	○	○	✓
Y	AMARILLO	✓	○	✓	○	○	○	○	○	○	○

* Las tuberías negras están estabilizadas contra luz UV.

✓ Indica que los colores estándar están disponibles.

○ Indica los colores opcionales que podrían estar disponibles según en la cantidad del pedido.

PRESIONES Y TEMPERATURAS LLDPE

Ø EXT. TUBO		Ø INT. TUBO	
1/4"	x	0.170"	230 psi a 70°F 15 bar a 20°C
5/16"	x	0.187"	
3/8"	x	0.25"	120 psi a 150°F 8 bar a 65°C
4mm	x	2.5mm	
6mm	x	4mm	
1/2"	x	0.375"	150 psi a 70°F 10 bar a 20°C
8mm	x	6mm	
10mm	x	7mm	90 psi a 150°F 6 bar a 65°C
12mm	x	9mm	
15mm	x	11.5mm	

1 Bar = 14.5 psi (aprox.)

La temperatura máxima de trabajo es de 150°F a las presiones que se indican en el cuadro anterior. Para temperaturas superiores a 150°F, los clientes deben comunicarse con nuestro departamento de soporte técnico.

Tenga en cuenta que el valor nominal de la presión máxima para un 'sistema' depende del componente con el menor valor nominal, por ejemplo: la mayoría de los conectores de John Guest tienen un valor nominal diferente de los valores nominales de los tubos que se muestran arriba.

Las presiones de rotura son aproximadamente 3 veces superiores a la presión máxima de trabajo.

RESISTENCIA QUÍMICA

Para uso con productos químicos o líquidos potencialmente agresivos, comuníquese con nuestro departamento de servicio técnico.

NOTA: Cuando utilice productos de limpieza u otros líquidos potencialmente agresivos, asegúrese de que sean compatibles con las tuberías y los conectores. No se aconseja LLDPE para aceites minerales, gases y combustibles, aire comprimido de alta presión o sistemas neumáticos.

EXPOSICIÓN A LUZ ULTRAVIOLETA

Las tuberías LLDPE negras de John Guest están estabilizadas contra rayos UV y pueden exponerse a luz ultravioleta directa (por ejemplo: luz solar directa). Otros colores de tuberías LLDPE de John Guest no están estabilizados contra rayos UV y no pueden exponerse a la luz ultravioleta directa.

APLICACIONES NEUMÁTICAS

Los tubos LLDPE de John Guest son adecuados para aplicaciones neumáticas siempre que la presión no supere los 150 psi a 70°F (10 bar a 20°C). A temperaturas elevadas de 120°F+ (50°C+), el aceite mineral degradará el tubo LLDPE, por lo que los tubos LLDPE utilizados en circuitos neumáticos deben controlarse en forma periódica y cambiarse cuando sea necesario.

TOLERANCIAS DE LOS TUBOS

1/4" to 1/2"	+0.001/-0.004"
De 4mm a 6mm	+0.05/-0.07mm
De 8mm a 12mm	+0.05/-0.10mm
15mm	+0.10/-0.10mm

CASQUILLOS PARA TUBO



Si el tubo se utiliza en un sistema de agua tibia, será necesario colocar un inserto para tubo.

NRO. DE PIEZA	Ø INT. TUBO	Ø EXT. TUBO	CANT. POR BOLSA	CANT. P. CAJA
TSI250S	1/4	5/16	10	1000
TSI312S	5/16	3/8	100	2500
TSI375S	3/8	1/2	10	500

APLICACIONES CON AGUA POTABLE

Las tuberías LLDPE de John Guest Ltd son adecuadas para aplicaciones con agua fría potable con un contenido de cloro MÁXIMO de 4 partes por millón (4 ppm). El agua calentada a más de 70°F (20°C) o las presiones superiores a la máxima reducirán en gran medida su vida útil. La exposición directa a la luz del sol también reducirá en gran medida su vida útil. Como parte de una buena práctica, las tuberías deben inspeccionarse en forma regular. Si existe algún indicio de daño, endurecimiento o grieta, deben cambiarse de inmediato.

NOTA: Los sistemas de plomería de agua fría y caliente deben cumplir con el código de plomería local para tuberías y conectores.



Accesorios en pulgadas o métricos

COBOTORES CASQUILLOS

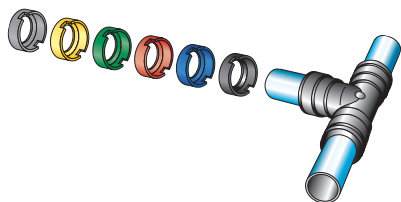

Las tapas de casquillos deslizantes que se muestran en la ilustración evitan la desconexión accidental o la manipulación de la tubería. La tubería puede introducirse con la tapa de casquillos ya fija a los conectores o la tapa puede deslizarse a su posición posteriormente. La tapa puede retirarse con facilidad en caso de ser necesario y se presenta en una variedad de colores que sirven para su codificación.

Colores disponibles: el sufijo indica el color.

E = Negro Y = Amarillo B = Azul

R = Rojo S = Gris G = Verde

Los precios están sujetos a cambios sin previo aviso.

TAMAÑO EN PULGADAS

NRO. DE PIEZA	Ø EXT. TUBO	CANT. P. CAJA
---------------	-------------	---------------

PM1904S	5/32	1000
PI1906S	3/16	1000
PI1908S	1/4	1000
PM1908S	5/16	1000
PI1912S	3/8	500
PI1916S	1/2	1000

En caso de no indicar el sufijo del color deseado, se suministrará el color gris.

TAMAÑO MÉTRICO

NRO. DE PIEZA	Ø EXT. TUBO	CANT. P. CAJA
---------------	-------------	---------------

PM1904E	4	1000
PM1905E	5	1000
PM1906E	6	1000
PM1908E	8	1000
PM1910E	10	500
PM1912E	12	500
PM1915E	15	400
PM1918E	18	200
PM1922E	22	200

Los tamaños de 15 mm a 22 mm sólo están disponibles en negro como estándar, blanco, rojo o azul.

En caso de no indicar el sufijo del color deseado, se suministrará en color negro.

GRAPA DE PARED 90°



NRO. DE PIEZA	Ø EXT. TUBO	CANT. P. CAJA
---------------	-------------	---------------

PM2608S	5/16 (8mm)	300
PM2610S	3/8 (10mm)	200

Diseñado para sostener el tubo y evitar que se doble.

CASQUILLO PARA TUBO



NRO. DE PIEZA	Ø INT. TUBO	Ø EXT. TUBO	CANT. P. CAJA
---------------	-------------	-------------	---------------

TSI250S	1/4	5/16	1000
TSI312S	5/16	3/8	2500
TSI375S	3/8	1/2	500
TSM10N		10	1000
TSM15N		15	500
TSM22N		22	250

HERRAMIENTA DE BLOQUEO/ LIBERACIÓN DEL CASQUILLO



NRO. DE PIEZA	TAMAÑOS	CANT. P. CAJA
---------------	---------	---------------

ICLT/2	3/16 to 1/2	50
TSPITool	1/4, 3/8	50

CORTADOR DE TUBO



NRO. DE PIEZA	CANT. P. CAJA
---------------	---------------

TSNIP	50
CHUCHILLAS BLADES	
SÓLO CHUCHILLAS	300

Adecuado para tubos de hasta 12 mm.

CORTADOR DE TUBERÍAS



PART NO.	BOX QTY
----------	---------

JG-TS	1
-------	---

Adecuado para tuberías de hasta 22 mm.

ABRAZADERA DE BLOQUEO



NRO. DE PIEZA	Ø EXT. TUBO	CANT. POR BOLSA	CANT. P. CAJA
---------------	-------------	-----------------	---------------

En pulgadas

PIC1808R	1/4	100	1000
PIC1812R	3/8	100	1000
PIC1816R	1/2	100	2000

Métrica

PMC1808R	8mm		8000
----------	-----	--	------



Fija el casquillo en su posición para evitar una desconexión accidental del tubo. Las abrazaderas de bloqueo deben conectarse sólo luego de la inserción completa para evitar que el tubo se raye.

Las abrazaderas de bloqueo no están diseñadas para su uso con adaptadores de espiga de John Guest en combinaciones giratorias.

Especificaciones técnicas

Rango de presión y temperatura de trabajo para conectores de acetil (PI, SI, SM y PM).

Los conectores **Super Speedfit®** son adecuados para las siguientes temperaturas y presiones.

Temp.	Presión	
	5/32" - 5/16"	3/8" - 1/2"
	4mm - 8mm	10mm - 22mm
Aire		
- 4°F	230 psi	150 psi
- 20°C	(16 Bar)	(10 Bar)
Líquidos potables y aire		
+33°F	230 psi	150 psi
+1°C	(16 Bar)	(10 Bar)
+68°F	230 psi	150 psi
+20°C	(16 Bar)	(10 Bar)
+150°F	150 psi	100 psi
+65°C	(10 Bar)	(7 Bar)

También son adecuados para su uso al vacío.

Para conocer el rango de presión y temperatura de trabajo de los productos de polipropileno, consulte la página 5.

Según el tubo que se utilice, en ciertas condiciones los conectores pueden utilizarse a presiones y temperaturas más elevadas. Comuníquese con nuestro departamento de soporte técnico para asesorarse. Tenga en cuenta que 1 Bar = 14.5 PSIG.

Tipos de tubos

Tubo de plástico: polietileno, nylon y poliuretano, de acuerdo con las tolerancias que se indican a continuación. Para tuberías blandas o con paredes delgadas, recomendamos el uso de inserto para tubos.

Tubo trenzado: el uso de espigas tubo a manguera que se indica en la página 9 es fundamental cuando se utiliza un tubo o una manguera trenzada. Se aconseja el uso de abrazaderas para retener el tubo trenzado en la manguera.

Tubo metálico (blando): latón, cobre o acero bajo en carbono, de acuerdo con las tolerancias que se indican a continuación.

Tubo metálico (duro): no recomendamos el uso de conectores Super Speedfit para tubos de metal duro o cromados.

Para los tubos de acero inoxidable y otros metales pulidos, recomendamos el uso de conectores Superseal. Se muestran en la página 12 de este catálogo.

Es fundamental que los diámetros exteriores no tengan estrías y que el tubo no tenga bordes antes de insertar el conector.

Tolerancias del tubo

Los conectores **Super Speedfit®** se ofrecen para tubos con diámetros exteriores que cumplan con las siguientes tolerancias.

Tamaño (pulgadas)	5/32 - 3/16	1/4 - 1/2
Tolerancia (pulgadas)	+0.001 / -0.003	+0.001 / -0.004
Tamaño (mm)	4mm - 5mm	6mm - 22mm
Tolerancia (mm)	+0.05 / -0.07	+0.05 / -0.10

Instalación y prueba del sistema

Los conectores y el tubo deben mantenerse limpios y en buen estado antes de ser utilizados.

Se deben probar a presión todas las instalaciones de tubos y conectores para garantizar la integridad del

sistema antes de entregarlo al usuario final. Consulte "Como realizar una conexión".

Productos químicos

Para uso con productos químicos u otros líquidos potencialmente agresivos, comuníquese con nuestro departamento de servicio técnico.

No se recomienda el uso de conectores Super Speedfit con gases explosivos, alcoholes de petróleo y otros combustibles, o para sistemas de calefacción central.

Cobertores de casquillos

Están disponibles como medidas de seguridad adicionales contra el desmontaje del tubo o para proporcionar un método sencillo de codificación por color. La tapa está disponible en una gama de seis colores. Consulte la página 23 de este catálogo.

Calidad alimentaria



Todos los conectores de este catálogo están fabricados con materiales aprobados por la Administración de Drogas y Alimentos (FDA) y por lo tanto se recomiendan para aplicaciones en el ámbito de la calidad alimentaria. La superficie húmeda de los conectores de plástico PI, PM, SI, CI, PP y NC, las válvulas PPSV y ASV y las tuberías PE de John Guest cumplen con los requisitos de la Administración de Drogas y Alimentos para el contacto directo con alimentos según se detalla en 21CFR sección 177.2470 para el cuerpo y sección 177.2600 para la junta tórica.

Normas Internacionales NSF 51 y 61.

Valores máximos de par de apriete para roscas de plástico BSP, BSPT y NPT.

No apriete demasiado los conectores con rosca de plástico ya que esto podría generar una tensión excesiva y posibles fallas. Las cifras máximas de par de apriete recomendadas se muestran a continuación.

	ROSCAS		
	1/8" - 1/4"	3/8" - 1/2"	3/4"
Par de torsión máximo	1.0ft lbs	2.2ft lbs	2.9ft lbs
	1.5Nm	3.0Nm	4.0Nm

John Guest recomienda que los clientes que sean fabricantes (OEM) tengan en cuenta reemplazar los orificios roscados con los sistemas de cartuchos más modernos.

Se recomienda controlar todas las instalaciones antes de su uso para determinar que estén selladas.

Las cifras máximas de par de torsión indicadas para el uso con conectores Speedfit dependen de que la rosca correspondiente cumpla con las normas de rosca internacionales, de Estados Unidos o de Gran Bretaña aplicables.

Intervalos de mantenimiento y cambio

Los productos de John Guest generalmente requieren poco mantenimiento, pero como mínimo recomendamos una inspección visual de rutina. La frecuencia de las inspecciones visuales dependerá de la severidad de la aplicación o el riesgo de fallas. Si luego de una inspección visual, los productos de John Guest se muestran dañados, agrietados, carbonizados, desteñidos, deformados por el calor u oxidados, deberán cambiarse. Cualquier producto que parezca tener o tenga filtraciones, debe ser cambiado. La vida útil del producto se ve afectada por la severidad de la aplicación, la hostilidad del ambiente de trabajo y el contacto con productos químicos o líquidos agresivos. Por lo tanto, es importante que los especificadores, usuarios o clientes tengan en cuenta los intervalos de cambio específicos según la vida útil previa o cuando la falla

podiera tener como resultado un tiempo de inactividad inaceptable, daño o riesgo de lesiones.

Productos de limpieza y desinfección de los conectores

Nuestro consejo para los clientes es que utilicen productos de limpieza y desinfección que superen el pH4 y que tengan un bajo nivel de hipoclorito. Los conectores de acetil y las piezas que se limpian o desinfectan deben enjuagarse de inmediato con grandes cantidades de agua de grifo neutral y limpia para eliminar todo rastro de los productos de limpieza. En nuestro catálogo hay información sobre qué productos están fabricados con acetil, pero generalmente, los productos de John Guest que tienen acetil están designados con el prefijo PI, PM, CI, CM y RM en el número de pieza. Los conectores de polipropileno ofrecen mayor resistencia a productos químicos agresivos que los conectores de acetil. El polipropileno no tiene las mismas propiedades mecánicas que el acetil y los conectores de polipropileno de John Guest generalmente se designan por el prefijo PP, PPSV y PPASV en el número de pieza.

Nuestros proveedores de materiales recomiendan ECOLAB Oasis 133 como el producto de limpieza externo adecuado para los productos fabricados por John Guest.

Responsabilidad de uso

Aunque ofrecemos una garantía por defectos en la fabricación o los materiales, es responsabilidad del usuario o instalador garantizar que los conectores y productos relacionados sean adecuados para su aplicación. La instalación debe llevarse a cabo correctamente de acuerdo con nuestras recomendaciones y conforme a códigos de práctica reconocidos y normas nacionales aplicables, y además deben mantenerse en forma adecuada. Consulte nuestros términos y condiciones de venta.

Carga lateral

Los conectores no deben ser sometidos a cargas laterales excesivas y no deben utilizarse como soportes. Las tuberías y los conectores deben tener un soporte adecuado para evitar las cargas laterales excesivas.

Selección e instalación de productos

Los conectores de John Guest y los productos relacionados están específicamente diseñados y fabricados por John Guest según las especificaciones técnicas establecidas en el catálogo de productos de John Guest. Todos los conectores de John Guest y los productos relacionados deben ser seleccionados, instalados, utilizados y mantenidos de acuerdo con estas especificaciones técnicas. Es responsabilidad del cliente o usuario garantizar que los conectores y productos relacionados de John Guest sean adecuados para las aplicaciones deseadas, que sean instalados y mantenidos de forma correcta, y que se utilicen según las especificaciones técnicas. También es responsabilidad del cliente o usuario proporcionar a sus clientes cualquier información técnica relevante sobre los productos de John Guest que les suministra.

La empresa tiene una política de permanente investigación y desarrollo, y se reserva el derecho de modificar sin previo aviso las especificaciones y los diseños de todos los productos descritos en este catálogo. John Guest se reserva el derecho de modificar el color y la forma de los productos. Las fotografías son para fines ilustrativos únicamente.

Consulte los términos y condiciones de venta que se incluyen en la página 25.

John Guest USA, Inc. no se responsabiliza por los errores de imprenta o tipográficos.

TERMS AND CONDITIONS

The products described in this document are hereby offered for sale to be established by John Guest (USA) Inc., its subsidiaries and its authorized distributors. This offer and its acceptance by any customer (the "Buyer") shall be governed by all of the following Terms and Conditions. Buyer's order for any item described in this document, when communicated to John Guest (USA) Inc., its subsidiaries or an authorized distributor (the "Seller") verbally or in writing, shall constitute acceptance of this offer.

1. Terms and Conditions of Sale. All descriptions, quotations, proposals, offers, acknowledgments, acceptances and sales of the Seller's products are subject to and shall be governed exclusively by the terms and conditions stated herein (the "Agreement"). The Buyer's acceptance of any offer to sell is limited to the terms and conditions in the Agreement. Any terms or conditions in addition to, or inconsistent with those stated in the Agreement, proposed by the Buyer in any acceptance of an offer by the Seller, are hereby objected to. No such additional, different or inconsistent terms and conditions shall become part of the agreement between the Buyer and the Seller unless expressly accepted in writing by the Seller. The Seller's acceptance of any offer to purchase by the Buyer is expressly conditioned upon the Buyer's assent to all the terms and conditions in this Agreement, irrespective of any terms in addition to, or inconsistent with those contained in the Buyer's offer. Acceptance of the Seller's products shall in all events constitute such assent.

2. Documents. Unless provided otherwise in the Agreement, all catalog descriptions, illustrations, drawings and literature or independently submitted estimates of performance, weights and measurements or other specifications provided by the Seller are mere approximations and the Seller reserves the right to alter or amend the same at any time. The Seller reserves the right to correct clerical or technical errors in the contract documents. The Buyer shall furnish with his order all necessary specifications and information. The Seller takes no responsibility for goods manufactured, priced or delivered not in accordance with the order or the specifications unless the Buyer's order and specifications are clear and correct.

3. Prices. Unless otherwise provided, all prices contained in our quotations and written acceptances are ex-works and do not include the cost of packing. All orders are accepted on the condition that all such prices are subject to revision by the Seller at any time before the goods are dispatched to take account of any price change. In the event that the Buyer does not place the entire order quoted by the Seller for the Buyer, the Seller reserves the right to revise its prices. The Seller also reserves the right to revise its prices if the Buyer modifies the specification or quantity of the goods, or the delivery requirements after the order has been accepted by the Seller.

4. Advice. All advice given in connection with the Seller's goods is provided without charge to the Buyer. Any advice and assistance given by the Seller to the Buyer is given at the Buyer's risk and the Seller shall not be liable for any loss, damage or claim arising therefrom.

5. Payment. (a) Unless otherwise provided in the Agreement, or explicitly agreed upon in writing by the Seller, payment is due in full 30 days from date of shipment of the items purchased herein under. (b) In the case of an installment contract, deliveries or parts, payment for each installment delivery or part shall be made under sub-clause (a) as if the same constituted a separate agreement. (c) Amounts not timely paid shall bear interest at the rate of 2-1/2% above the Seller's bank's prime rate from time to time in force. (d) In the event that the Buyer fails within one calendar month of the date for payment to effect any payment which may be due under the Agreement or any agreement with the Seller, or if the Buyer commits any breach of the Agreement, or if the Buyer becomes insolvent or commits any act of bankruptcy or contemplation of liquidation, the Seller will be entitled, without prejudice to the Seller's other rights, to terminate the Agreement or any unfulfilled part thereof, or at the Seller's option to make partial deliveries.

6. Modifications and Cancellations. This Agreement is not subject to oral modification or cancellation. A Buyer's request for modification or cancellation will not be incorporated into the Agreement unless the request is accepted by the Seller in a writing that amends the Agreement. Acceptance of any such requested modification or cancellation shall be at the Seller's discretion and shall be upon such terms and conditions as the Seller may require.

7. Handling Charge. Goods supplied in accordance with the Buyer's order may later be returned to the Seller at the Seller's discretion provided the return is pre-authorized, in writing and the merchandise is unused, in original packages, unaltered, clean and no older than 60 days from the date of shipment by the Seller. The Buyer will be required to pay to the Seller a handling charge of 15%

of the purchase price of the returned goods. A copy of the original invoice for the merchandise must accompany all returns.

8. Delivery. (a) Any delivery dates quoted are approximate only and the Seller shall have no liability for any delays in delivery. (b) Unless provided otherwise, delivery of the goods shall be made when the Seller has notified the Buyer that the goods are ready for dispatch. Regardless of the method of delivery, delivery shall be made F.O.B. Seller's plant, where the risk of loss shall thereupon pass to the Buyer upon the Seller's delivery to a carrier. Notwithstanding that the Seller's prices are ex-works, the Seller is prepared by special contract to procure carriage or freight and insurance on behalf of the Buyer and at Buyer's cost in which event the Seller shall be under no liability for damage in transit or loss or damage to the goods beyond the point at which the Seller contracts to deliver the same. (c) Seller will not make drop shipments.

9. Inspection and Rejection. (a) The following provisions shall apply in relation to all deliveries of goods: the Seller shall not be held liable for any claims of damage in transit, shortage of delivery or loss of goods, unless in the case of shortage of delivery, a separate notice in writing is given to the carrier concerned and to the Seller within three (3) days of the receipt of the goods, followed by a complete claim in writing within five (5) days of receipt of the goods and in the case of loss of goods, a separate notice in writing is given to the carrier concerned and to the Seller and a complete claim in writing made within thirty (30) days of the date of consignment. The Buyer must inspect the goods on arrival from the carrier, however, where goods are accepted from the carrier concerned without being inspected, the delivery book of the carrier concerned must be signed "not examined". The Seller shall have the right to inspect the goods at the Buyer's premises in respect to any such claims made by the Buyer and the Buyer shall retain such goods until the Seller has inspected such goods or until the Seller has notified the Buyer that the Seller does not wish to inspect such goods. Any breach of these conditions in this provision shall serve as a waiver to any claim brought by the buyer. (b) Without prejudice to the Seller's other rights, should the Buyer fail for any reason to send the Seller forwarding instructions within ninety (90) days after the date of the Seller's notification that the goods are ready for dispatch or to accept delivery of the goods, the Seller shall be entitled at the Buyer's risk and expense to store the goods and/or to procure or effect storage of the goods elsewhere. Goods so stored shall be paid for as if they had been dispatched and/or accepted.

10. Special Tooling. Where it is necessary for the Seller to manufacture or to purchase special tooling, including without limitation tools, dies, jigs, mandrills, fixtures, molds, and patterns in order to execute a contract, the Buyer will be charged with a proportion of the cost of such special tools. Such special tooling shall be and remain the Seller's property notwithstanding payment of any charges made by the Buyer. In no event will the Buyer acquire any interest in apparatus belonging to the Seller which is utilized in the manufacture of the items sold hereunder, even if such apparatus has been specially converted or adopted for such manufacture and notwithstanding any charges paid by the Buyer therefore. Unless otherwise agreed, the Seller shall have the right to alter, discard or otherwise dispose of any special tooling or other property in its sole discretion at any time.

11. Test and Performance. (a) The Seller's goods are, where practicable, submitted to the Seller's standard test before delivery. If special tests are required, these shall be made at the Seller's premises unless otherwise agreed, and will be subject to an extra charge. (b) The Seller accepts no liability for failure to attain any performance figures quoted by the Seller unless the Seller specifically has guaranteed them with an agreed sum as liquidation damages and the Buyer has suffered actual loss by reason of the failure to attain the figures quoted. (c) Any particulars of weights and measurements, power and consumption, power output or performance relating to the goods and like matters furnished by the Seller to the Buyer in the Seller's catalogs, literature or otherwise, are approximate and are intended only to present a general idea of the goods to be supplied and unless previously agreed specifically in writing shall not form part of the Agreement.

12. Buyer's Property. Any designs, tools, patterns, materials, drawings, confidential information or equipment furnished to the Seller by the Buyer, or any other items which become the Buyer's property, may be considered obsolete and may be destroyed by the Seller after two (2) consecutive years have elapsed without the Buyer placing an order for the items which are manufactured using such property. The Seller shall not be responsible for any loss or damage to such property while it is in the Seller's possession or control.

13. Taxes. Unless otherwise indicated, all prices and charges are exclusive of excise, sales, use, property, occupational or like taxes which may be imposed by any taxing authority upon the manufacture, sale or delivery of the items sold hereunder. If any such taxes must be paid by the Seller, or if the Seller is liable for

the collection of such tax, the amount thereof shall be in addition to the amounts for the item sold. The Buyer agrees to pay all such taxes or to reimburse the Seller therefore upon receipt of its invoice. If the Buyer claims exemption from any sales, use or other tax imposed by any taxing authority, the Buyer shall promptly indemnify and hold the Seller harmless from and against any such tax, as well as any interest or penalties thereon which may be assessed if the items are held to be taxable.

14. Warranty. (a) The Seller warrants that the items sold hereunder shall be free from defects in material or workmanship at the time of shipment by the Seller. The Seller warrants that if within 12 months of delivery of the goods to the Buyer the Buyer returns immediately to the Seller's premises any of the said goods which the Buyer believes to be defective, carrier paid, properly packed and clearly marked with the Buyer's full name and address and any other information such as serial numbers which may be necessary to enable the goods to be identified, together with a complete description of the respects in which it is alleged that the goods are defective, they will be repaired or new goods will be supplied in exchange and the goods so repaired or such new goods will be delivered to the Buyer free of charge at the Seller's premises provided that the foregoing warranty shall only be applicable if upon demand by the Seller, the Buyer proves to the Seller's satisfaction: (i) that the defect was due solely to defective workmanship; (ii) that no alterations or repairs have been made to the goods except with the Seller's written consent; (iii) that the defect was not caused by any act of the Buyer or its agents; and (iv) that the defect was not caused by any matter beyond the reasonable control of the Seller, including, without limitation, accident or normal wear and tear. The benefit of this warranty shall not be assignable by the Buyer. (b) The warranty contained in sub-paragraph (a) above does not extend to any goods not manufactured by the Seller even though supplied by the Seller nor does it extend to any second-hand or reconditioned goods nor does it extend to components manufactured by the Seller but installed, attached or welded by the Buyer or his customer on equipment not manufactured by the Seller. Goods not manufactured by the Seller carry only the warranty (if any) of their makers and the Buyer is entitled to the benefit thereof only so far as the Seller has the power to transfer it. (c) This warranty comprises the sole and entire warranty pertaining to items provided hereunder; the Seller makes no other warranty, guarantee, or representation of any kind whatsoever. All other warranties, including but not limited to, merchantability and fitness for purpose, whether expressed or implied, or arising by operation of law, trade usage, or course of dealing are hereby disclaimed. (d) Notwithstanding the foregoing, there are no warranties whatsoever on items built or acquired wholly or partially to the Buyer's designs or specifications.

15. Limited Remedy. The Seller's liability arising from or in any way connected with the items sold or this Agreement shall be limited exclusively to repair or replacement of the items sold. In no event shall the Seller be liable to the Buyer or any 3rd party for any incidental, consequential or special damages of any kind or nature whatsoever, including but not limited to lost profits arising from or in any way connected with this agreement or items sold hereunder, whether alleged to arise from breach of contract, express or implied warranty, or in tort, including without limitation, negligence, failure to warn or strict liability.

16. Indemnity for Infringement of Intellectual Property Rights. (a) The Buyer shall defend and indemnify the Seller against all actions, claims, demands, penalties and costs by 3rd parties in tort, or for infringement, or alleged infringement, of patents, trademarks, copyrights, trade dress, trade secret or other rights of any 3rd party resulting from the goods manufactured in accordance with the Buyer's specifications or based on any information provided by the Buyer. The Buyer will defend any action against the Seller for title, patent, trademark, copyright infringement, or other claimed by a 3rd party at the Buyer's sole cost and expense. (b) The Seller shall have no liability for infringement of any patents, trademarks, copyrights, trade dress, trade secrets or similar rights except as provided in this provision. The Seller will defend and indemnify the Buyer against allegations of infringement of US patents, US trademarks, copyrights, trade dress and trade secrets ("Intellectual Property Rights"). The Seller will defend at its expense and will pay the cost of any settlement or damages awarded in an action brought against the Buyer based on an allegation that an item sold pursuant to this contract infringes the Intellectual Property Rights of a 3rd party. The Seller's obligation to defend and indemnify the Buyer is contingent on the Buyer notifying the Seller within 10 days after sole control over the defense of any allegations or actions, including all negotiations for settlement or compromise. If an item sold hereunder is subject to a claim that it infringes the Intellectual Property Rights of a 3rd party, the Seller may, at its sole expense and option, procure for the Buyer the right to continue using said item, replace or modify said item so as to make it non-infringing, or offer to accept return of said item and return the purchase price less a reasonable allowance

for depreciation. Notwithstanding the foregoing, the Seller shall have no liability for claims of infringement based on information provided by Buyer, or directed to items delivered hereunder for which the designs are specified in combination or use in a system of any item sold hereunder. The foregoing in this provision shall constitute the Seller's sole and exclusive liability and the Buyer's sole and exclusive remedy for infringement of Intellectual Property Rights.

17. Lien. In addition to any right of lien to which the Seller may by law be entitled, the Seller shall have a general lien on all goods of the Buyer in the Seller's possession (although such goods or some of them may have been paid for) for the unpaid price of any other goods sold and delivered to the Buyer by the Seller under the same or other contracts.

18. Waiver. The Seller's rights shall not be affected or restricted by any indulgence or forbearance granted to the Buyer. No waiver by the Seller of any breach shall operate as a waiver of any later breach.

19. Force Majeure. The Seller shall be excused from performing any of its obligations under this Agreement which are prevented or delayed by any occurrence not within the reasonable control of the Seller, including but not limited to, accidents, acts of God, destruction or damage to the goods or the Seller's manufacturing plant, delays or failures in delivery of carriers or suppliers, shortages of materials, strikes or other labor matters, floods, earthquakes, fire, riots, explosions, or any regulations, rules, ordinances or orders of any governmental authority, federal, state or local, whether such cause exists at the date of the order or not.

20. Buyer's Representation of Solvency. The Buyer hereby represents that as of the signing of this Agreement it was not insolvent within the meaning of the Uniform Commercial Code or the Bankruptcy Laws of the United States.

21. Assignment and Delegation. The rights and obligations of the parties under this Agreement may not be assigned or delegated, except on the express written consent of the other party to the assignment or delegation.

22. Integration. The rights and obligations of the parties and the terms and conditions set forth herein, together with any amendments, modifications and any different terms and conditions expressly accepted by the Seller in writing, shall constitute a complete and exclusive statement of the terms of this Agreement. This Agreement supersedes not only all prior agreements, but also oral agreements made contemporaneously with the execution of this Agreement. All such materials may not be used to supplement, explain, or contradict the terms of this Agreement.

23. Severability. If any of these conditions or any part thereof purports to exclude or restrict or limit any liability and such exclusion or restriction or limitation is prohibited or rendered void or unenforceable by any legislation to which it is subject, or is itself prohibited or rendered void or unenforceable by any legislation to which it is subject, then the exclusion restriction or limitation on the condition or part thereof in question shall be so prohibited or rendered void or unenforceable and the validity or enforceability of any other part of these provisions shall not thereby be affected.

24. Governing Law/Limitation on Actions. The terms, conditions, rights, and obligations under this Agreement shall be construed under the laws of the State of New York, without regard to principles of conflicts of laws. No actions arising out of the sale of the items sold hereunder or this Agreement may be brought by the Buyer more than two (2) years after such cause of action accrues.

Empresas John Guest



John Guest USA, un proveedor de productos para sistemas de fluidos líder en el mundo, ubicado en el norte de Nueva Jersey, es parte de una organización profesional y progresista con diversas sedes en el mundo. Durante más de 30 años, la organización John Guest ha forjado su reputación al ofrecer productos de alta calidad y altos niveles de servicio de atención al cliente.

A través de un compromiso firme con el crecimiento y la innovación, John Guest USA continuará sirviendo a su comunidad y a sus clientes durante muchos años más.

John Guest USA, Inc. distribuye sus productos en América del Norte, América Central, América del Sur, el Caribe y las Islas Virgenes de Estados Unidos.



John Guest USA Inc.

180 Passaic Avenue
PO Box 11085
Fairfield, NJ 07004
Tel: 973-808-5600
Número telefónico gratuito: 1-800-94-JG USA
Fax: 973-808-5036
Fax gratuito: 1-877-77-JG FAX
Sitio web: www.johnguest.com
Correo electrónico: info@jgusa.com



John Guest Ltd.

Horton Road, West Drayton, Middlesex, UB7 8JL, England.
Tel: (44) (1) (895) 449233 Fax: (44) (1) (895) 420321



John Guest France S.A.

143-147 Avenue Charles Floquet, Parc Gustave Eiffel,
93593 Le Blanc Mesnil, Cedex, FRANCE.
Tel: (33) (1) 48 65 52 29 Fax: (33) (1) 48 65 43 40



John Guest GmbH

Ludwig-Erhard-Allee 30, D-33719 Bielefeld, GERMANY
Tel: (49) (521) 972 560 Fax: (49) (521) 972 5680



John Guest Czech s.r.o.

Vrbenska 2290, CZ - 37001 Ceske Budejovice, CZECH REPUBLIC.
Tel: (420) (387) 002 040 Fax: (420) (387) 002 048



John Guest Polska Sp. z o.o.

Ul. Starolecka 7, 61-361, Poznan, POLAND.
Tel: (48) (61) 87 80 408 Fax: (48) (61) 87 80 285



John Guest s.r.l.

Via Vincenzo Lancia 13, 10038 Casabianca-Verolengo (Torino), ITALY.
Tel: (39) (011) 957 5880 Fax: (39) (011) 957 6144



John Guest s.l.

C/ de La Electronica No.7, Poligono Industrial La Ferreria,
Montcada i Reixac, 08110 Barcelona, SPAIN.
Tel: (34) (93) 575 0027 Fax: (34) (93) 575 0178



John Guest Korea Ltd

Unit 552-27 Kajwa Dong, Seo Ku,
Incheon City, 404-812 Korea.
Tel: (82) (32) 584 3370 Fax: (82) (32) 584 3372



John Guest Pacific Ltd

P.O. Box 19553, 606 Rosebank Road, Avondale,
Auckland, NEW ZEALAND.
Tel: (64) (9) 8281353 Fax: (64) (9) 828 5927



John Guest Pacific Ltd

Unit 6, 33 Nyrang Street, Lidcombe, Sydney
N.S.W. 2141, AUSTRALIA.
Tel: (61) (2) 9737 9088 Fax: (61) (2) 9737 9122